

# Spezifikation für Freigabe / specification for release

Kunde / customer : \_\_\_\_\_  
 Artikelnummer / part number : **74457122**  
 Bezeichnung : **SMD-SPEICHERDROSSEL WE-PD 4**  
 description : **POWER-CHOKE WE-PD 4**



DATUM / DATE : 2003-01-20

## A Mechanische Abmessungen / dimensions:

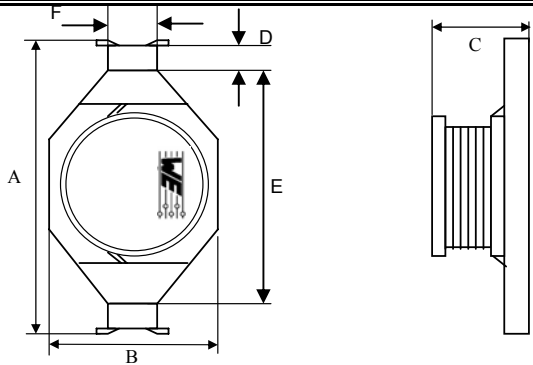

	Typ XL	
A	<b>22,0 ± 0,3</b>	mm
B	<b>15,0 ± 0,3</b>	mm
C	<b>7,0 +0,8/-0,4</b>	mm
D	<b>2,3 (typ)</b>	mm
E	<b>15,0 (typ)</b>	mm
F	<b>8,0 (typ)</b>	mm
G		mm
H		mm
I		mm

## B Elektrische Eigenschaften / electrical properties:

Eigenschaften / properties	Testbedingungen / test conditions		Wert / value	Einheit / unit	tol.
Induktivität / inductance	<b>100 kHz / 1V</b>	L	<b>22,00</b>	μH	<b>±15%</b>
max. Strom / max. Current	<b>ΔL/Lo= 10% max.</b>	I <sub>sat</sub>	<b>6,50</b>	A	<b>max.</b>
DC-Widerstand / DC-resistance		R <sub>DC</sub>	<b>39,4</b>	mΩ	<b>max.</b>
Nennstrom / rated current	<b>ΔT = +40°C</b>	I <sub>DC</sub>	<b>4,00</b>	A	<b>max.</b>
Eigenres.-Frequenz / self-res.-frequency		SRF		MHz	

## C Lötpad / soldering spec.:

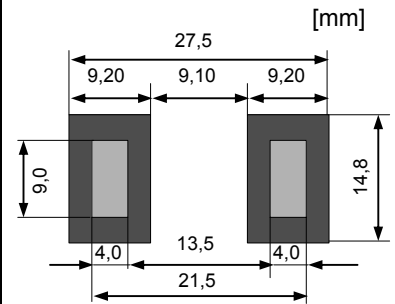

## D Prüfgeräte / test equipment:

**HP 4274 A** für/for L und/and Q  
**HP 34401 A** für/for I<sub>DC</sub> und/and R<sub>DC</sub>

## E Testbedingungen / test conditions:

Luftfeuchtigkeit / humidity: 33%  
 Umgebungstemperatur / temperature: +20°C

## F Werkstoffe & Zulassungen / material & approvals

Basismaterial / base material: Ferrit/ferrite  
 Draht / wire: 2 UEW; 130°C

## G Eigenschaften / general specifications:

Lagertemperatur / storage temperature: -40°C - + 105°C  
 Betriebstemp. / operating temperature: -40°C - +85°C

Freigabe erteilt / general release:	<b>Kunde / customer</b>				
Datum / date	Unterschrift / signature				
	<b>Würth Elektronik</b>		RT	Update	2003-01-20
			MST	Update	2002-03-27
	.....AG.....		JH	Neugestaltung	2000-12-06
Geprüft / checked	Kontrolliert / approved		Name	<b>Änderung / modification</b>	Datum / date

### Würth Elektronik eiSos GmbH & Co. KG