

9A HIGH-SPEED MOSFET DRIVERS

FEATURES

- Tough CMOS™ Construction
- High Peak Output Current 9A
- High Continuous Output Current 2A Max
- Fast Rise and Fall Times:
 - 30 nsec with 4,700 pF Load
 - 180 nsec with 47,000 pF Load
- Short Internal Delays 30nsec Typ
- Low Output Impedance 1.4W Typ

APPLICATIONS

- Line Drivers for Extra-Heavily-Loaded Lines
- Pulse Generators
- Driving the Largest MOSFETs and IGBTs
- Local Power ON/OFF Switch
- Motor and Solenoid Driver

PIN CONFIGURATIONS

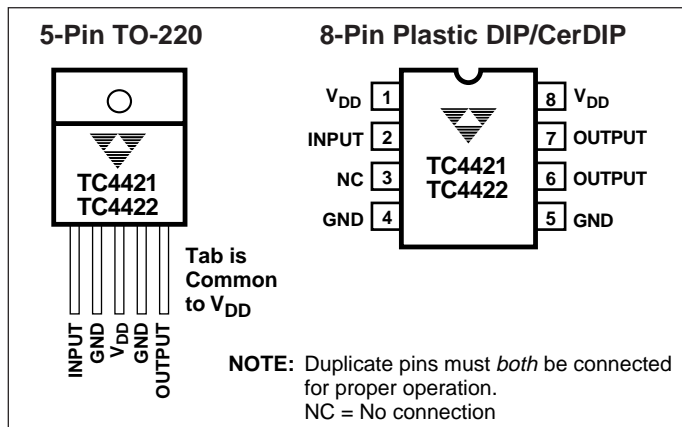

GENERAL DESCRIPTION

The TC4421/4422 are high current buffer/drivers capable of driving large MOSFETs and IGBTs.

They are essentially immune to any form of upset except direct overvoltage or over-dissipation — they cannot be latched under any conditions within their power and voltage ratings; they are not subject to damage or improper operation when up to 5V of ground bounce is present on their ground terminals; they can accept, without either damage or logic upset, more than 1A inductive current of either polarity being forced back into their outputs. In addition, all terminals are fully protected against up to 4 kV of electrostatic discharge.

The TC4421/4422 inputs may be driven directly from either TTL or CMOS (3V to 18V). In addition, 300 mV of hysteresis is built into the input, providing noise immunity and allowing the device to be driven from slowly rising or falling waveforms.

4

ORDERING INFORMATION

Part No.	Package	Temperature Range
TC4421CAT	5-Pin TO-220	0°C to +70°C
TC4421CPA	8-Pin PDIP	0°C to +70°C
TC4421EPA	8-Pin PDIP	– 40°C to +85°C
TC4421MJA	8-Pin CerDIP	– 55°C to +125°C
TC4422CAT	5-Pin TO-220	0°C to +70°C
TC4422CPA	8-Pin PDIP	0°C to +70°C
TC4422EPA	8-Pin PDIP	– 40°C to +85°C
TC4422MJA	8-Pin CerDIP	– 55°C to +125°C

FUNCTIONAL BLOCK DIAGRAM

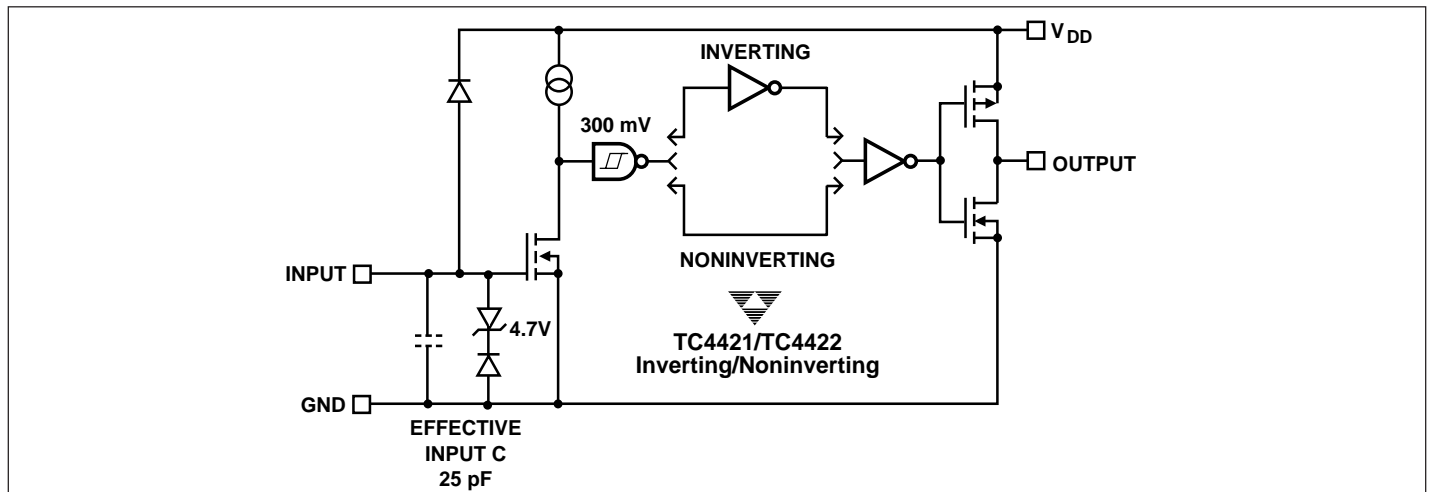

TC4421 TC4422

ABSOLUTE MAXIMUM RATINGS*

Power Dissipation, $T_A \leq 70^\circ\text{C}$	
PDIP	730W
CerDIP	800mW
5-Pin TO-220	1.6W
Power Dissipation, $T_A \leq 70^\circ\text{C}$	
5-Pin TO-220 (With Heat Sink)	1.60W
Derating Factors (To Ambient)	
PDIP	8mW/ $^\circ\text{C}$
CerDIP	6.4mW/ $^\circ\text{C}$
5-Pin TO-220	12mW/ $^\circ\text{C}$
Thermal Impedance (To Case)	
5-Pin TO-220 R_{QJ-C}	10 $^\circ\text{C}/\text{W}$
Storage Temperature	- 65 $^\circ\text{C}$ to +150 $^\circ\text{C}$
Operating Temperature (Chip)	150 $^\circ\text{C}$

Operating Temperature (Ambient)

C Version	0 $^\circ\text{C}$ to +70 $^\circ\text{C}$
E Version	- 40 $^\circ\text{C}$ to +85 $^\circ\text{C}$
M Version	- 55 $^\circ\text{C}$ to +125 $^\circ\text{C}$
Lead Temperature (10 sec)	300 $^\circ\text{C}$
Supply Voltage	20V
Input Voltage	($V_{DD} + 0.3\text{V}$) to (GND - 5V)
Input Current ($V_{IN} > V_{DD}$)	50 mA

*Static-sensitive device. Unused devices must be stored in conductive material. Protect devices from static discharge and static fields. Stresses above those listed under "Absolute Maximum Ratings" may cause permanent damage to the device. These are stress ratings only and functional operation of the device at these or any other conditions above those indicated in the operation sections of the specifications is not implied. Exposure to absolute maximum rating conditions for extended periods may affect device reliability.

ELECTRICAL CHARACTERISTICS: $T_A = 25^\circ\text{C}$ with $4.5\text{V} \leq V_{DD} \leq 18\text{V}$ unless otherwise specified.

Symbol	Parameter	Test Conditions	Min	Typ	Max	Unit
Input						
V_{IH}	Logic 1 Input Voltage		2.4	1.8	—	V
V_{IL}	Logic 0 Input Voltage		—	1.3	0.8	V
I_{IN}	Input Current	$0\text{V} \leq V_{IN} \leq V_{DD}$	- 10	—	10	μA
Output						
V_{OH}	High Output Voltage	See Figure 1	$V_{DD} - 0.025$	—	—	V
V_{OL}	Low Output Voltage	See Figure 1	—	—	0.025	V
R_O	Output Resistance, High	$V_{DD} = 18\text{V}$, $I_O = 10\text{mA}$	—	1.4	—	Ω
R_O	Output Resistance, Low	$V_{DD} = 18\text{V}$, $I_O = 10\text{mA}$	—	0.9	1.7	Ω
I_{PK}	Peak Output Current	$V_{DD} = 18\text{V}$	—	9	—	A
I_{DC}	Continuous Output Current	$10\text{V} \leq V_{DD} \leq 18\text{V}$, $T_C = 25^\circ$ (TC4421/22 CAT only)	2	—	—	A
I_{REV}	Latch-Up Protection	Duty Cycle $\leq 2\%$ Withstand Reverse Current	>1500 $t \leq 300\ \mu\text{sec}$	—	—	mA
Switching Time (Note 1)						
t_R	Rise Time	Figure 1, $C_L = 10,000\ \text{pF}$	—	60	75	nsec
t_F	Fall Time	Figure 1, $C_L = 10,000\ \text{pF}$	—	60	75	nsec
t_{D1}	Delay Time	Figure 1	—	30	60	nsec
t_{D2}	Delay Time	Figure 1	—	33	60	nsec
Power Supply						
I_S	Power Supply Current	$V_{IN} = 3\text{V}$ $V_{IN} = 0\text{V}$	— —	0.2 55	1.5 150	mA μA
V_{DD}	Operating Input Voltage		4.5	—	18	V
Input						
V_{IH}	Logic 1 Input Voltage		2.4	—	—	V
V_{IL}	Logic 0 Input Voltage		—	—	0.8	V
I_{IN}	Input Current	$0\text{V} \leq V_{IN} \leq V_{DD}$	- 10	—	10	μA

ELECTRICAL CHARACTERISTICS (cont.):

Measured over operating temperature range with $4.5V \leq V_S \leq 18V$ unless otherwise specified.

Symbol	Parameter	Test Conditions	Min	Typ	Max	Unit
Input						
V_{IH}	Logic 1 Input Voltage		2.4	—	—	V
V_{IL}	Logic 0 Input Voltage		—	—	0.8	V
I_{IN}	Input Current	$0V \leq V_{IN} \leq V_{DD}$	-10	—	10	μA
Output						
V_{OH}	High Output Voltage	See Figure 1	$V_{DD} - 0.025$	—	—	V
V_{OL}	Low Output Voltage	See Figure 1	—	—	0.025	V
R_O	Output Resistance, High	$V_{DD} = 18V, I_O = 10\text{ mA}$	—	2.4	3.6	Ω
R_O	Output Resistance, Low	$V_{DD} = 18V, I_O = 10\text{ mA}$	—	1.8	2.7	Ω
Switching Time (Note 1)						
t_R	Rise Time	Figure 1, $C_L = 10,000\text{ pF}$	—	60	120	nsec
t_F	Fall Time	Figure 1, $C_L = 10,000\text{ pF}$	—	60	120	nsec
t_{D1}	Delay Time	Figure 1	—	50	80	nsec
t_{D2}	Delay Time	Figure 1	—	65	80	nsec
Power Supply						
I_S	Power Supply Current	$V_{IN} = 3V$ $V_{IN} = 0V$	—	0.45 0.06	3 0.2	mA
V_{DD}	Operating Input Voltage		4.5	—	18	V

NOTE: 1. Switching times guaranteed by design.

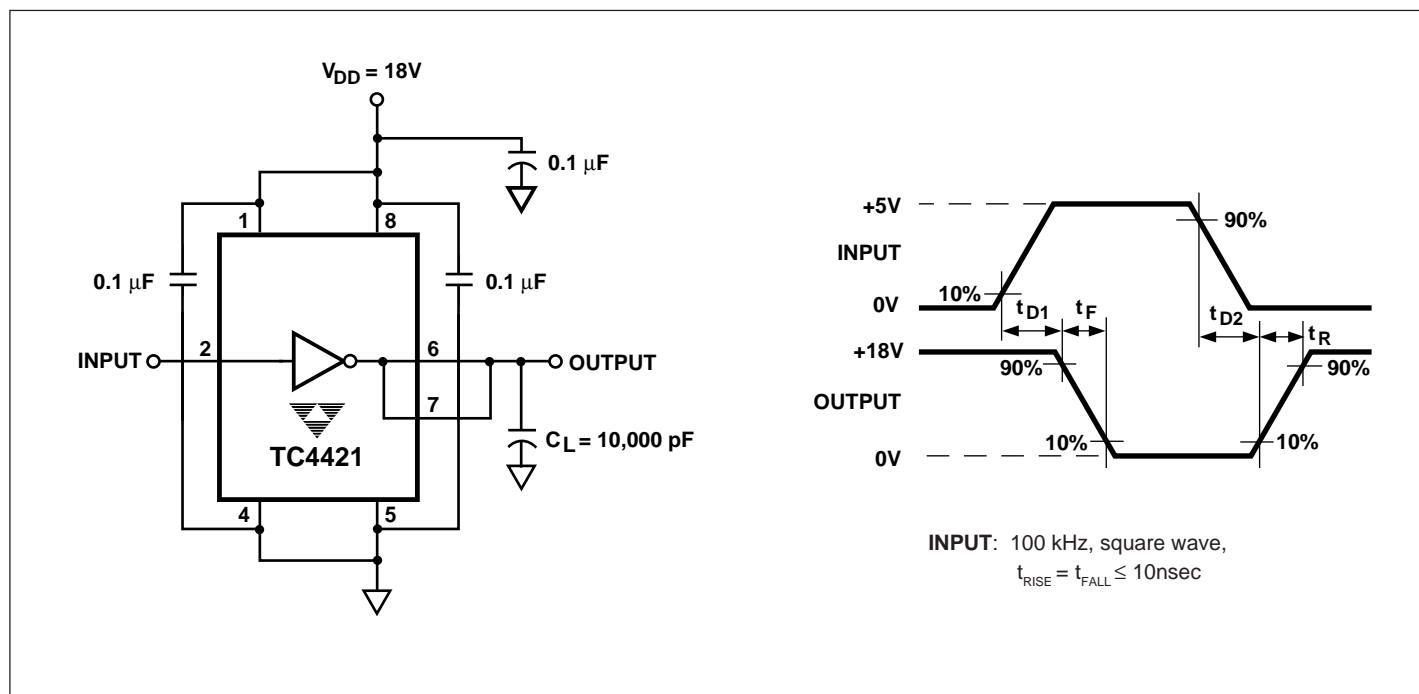
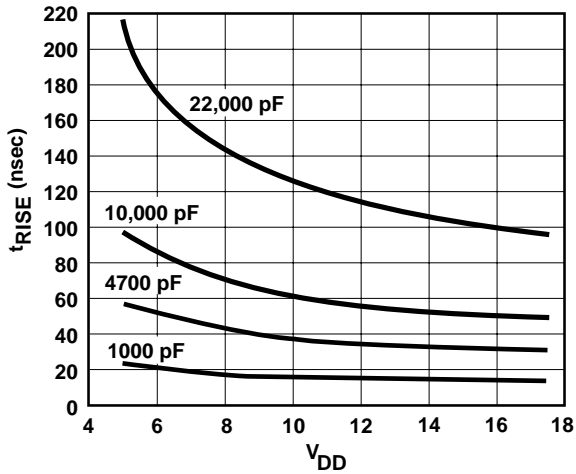

Figure 1. Switching Time Test Circuit

TC4421
TC4422

TYPICAL CHARACTERISTICS

Rise Time vs. Supply Voltage



Fall Time vs. Supply Voltage

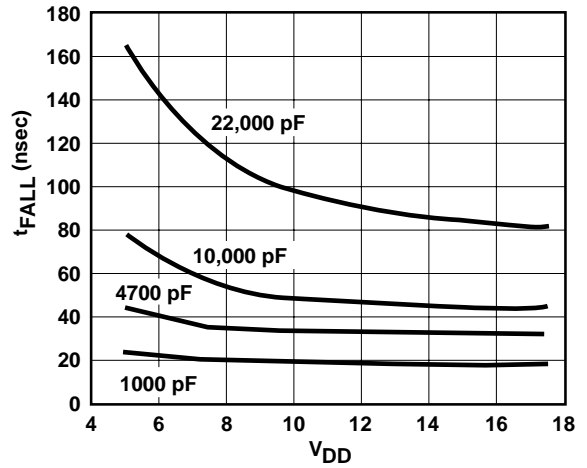

Rise Time vs. Capacitive Load

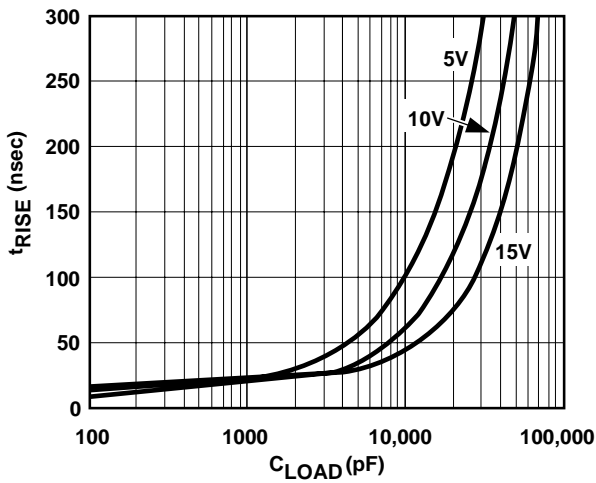

Fall Time vs. Capacitive Load

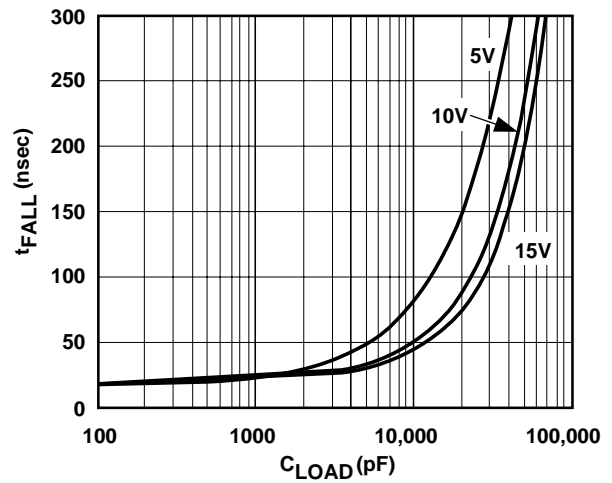

Rise and Fall Times vs. Temperature

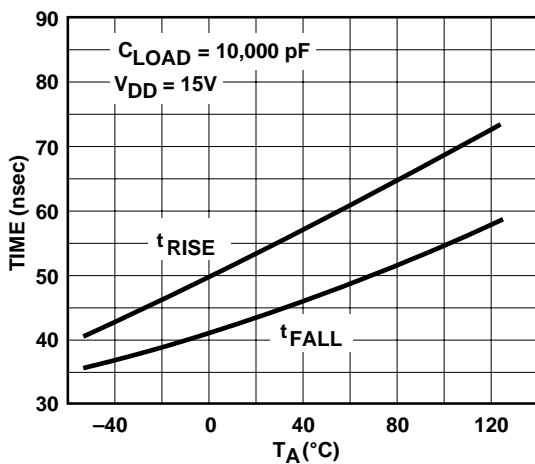

Propagation Delay vs. Supply Voltage

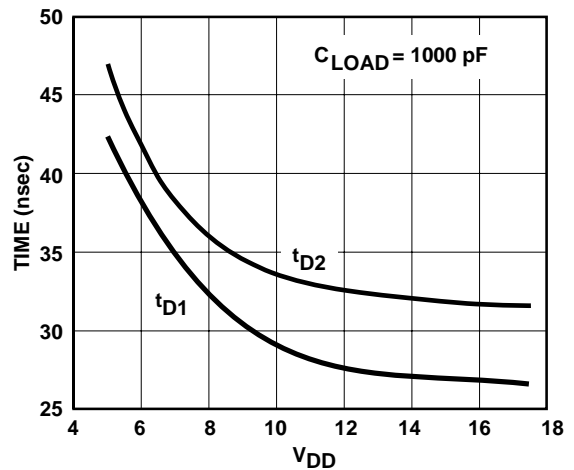

TYPICAL CHARACTERISTICS (Cont.)

Supply Current vs. Capacitive Load
($V_{DD} = 18V$)

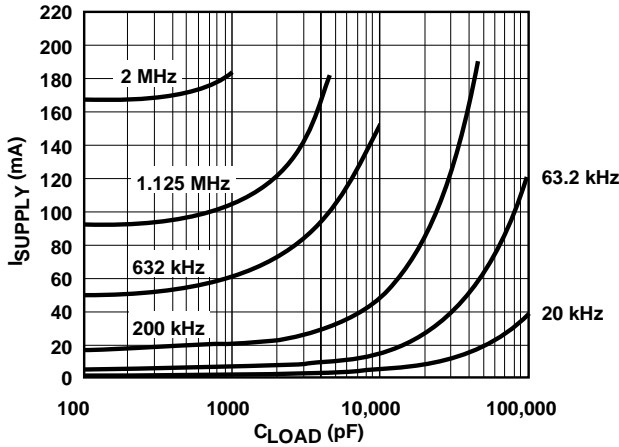

Supply Current vs. Frequency
($V_{DD} = 18V$)

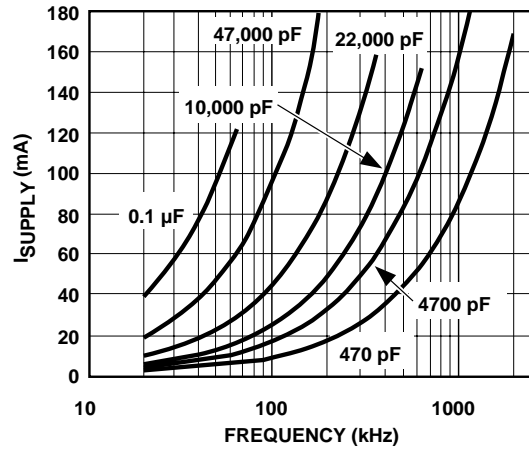

Supply Current vs. Capacitive Load,
($V_{DD} = 12V$)

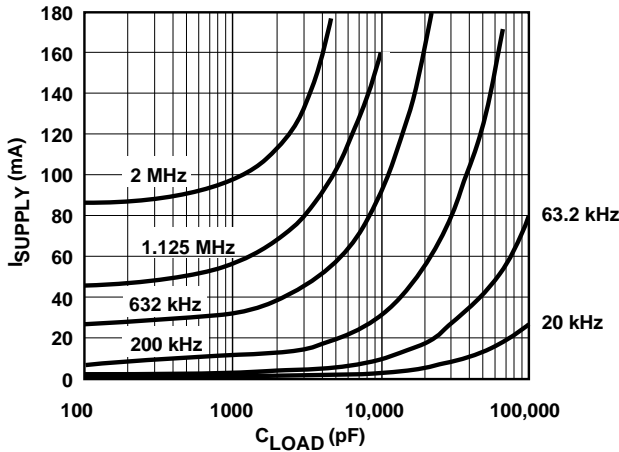

Supply Current vs. Frequency
($V_{DD} = 12V$)

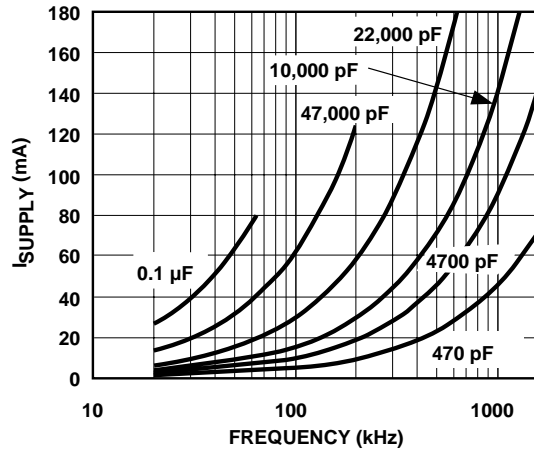

Supply Current vs. Capacitive Load
($V_{DD} = 6V$)

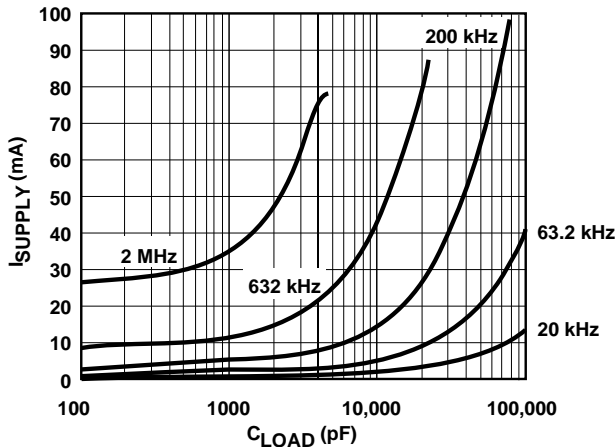

Supply Current vs. Frequency
($V_{DD} = 6V$)

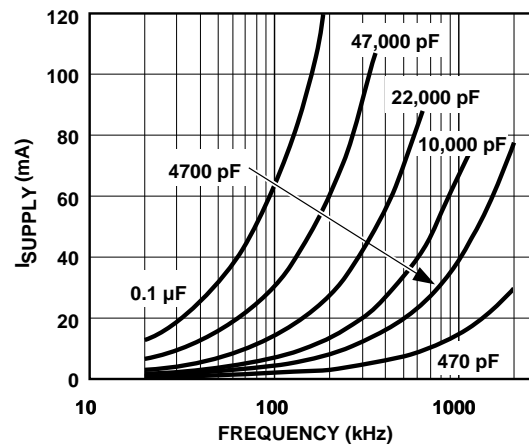

TC4421
TC4422

TYPICAL CHARACTERISTICS (Cont.)

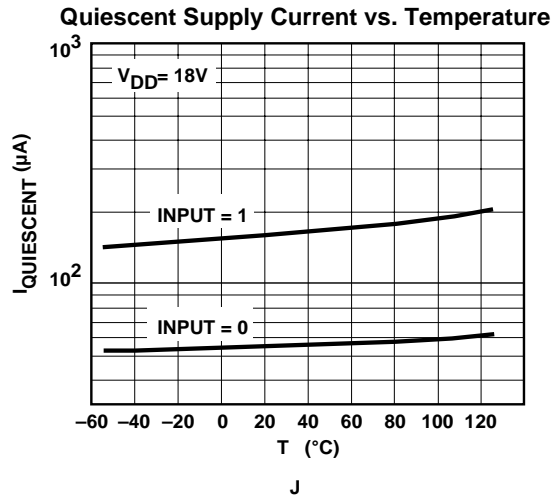
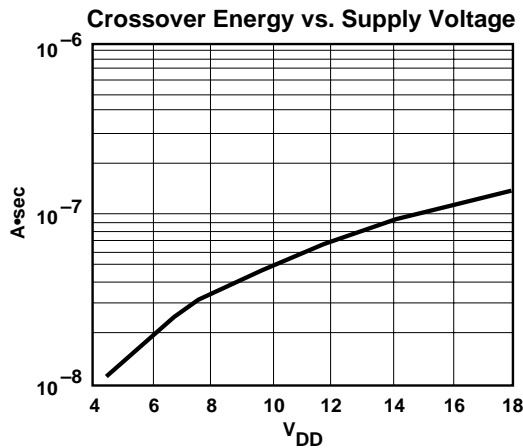
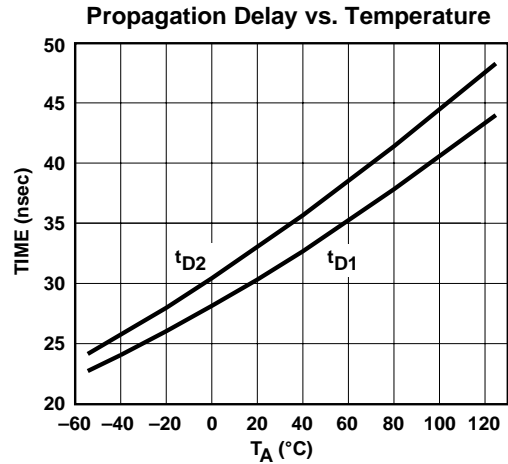
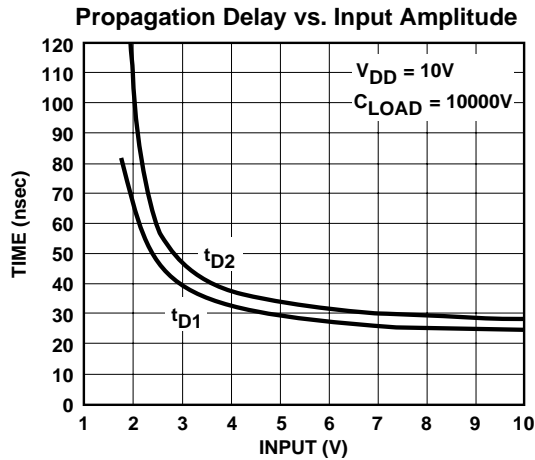

NOTE: The values on this graph represent the loss seen by the driver during a complete cycle. For the loss in a single transition, divide the stated value by 2.

