

DESCRIPTION

SRC Device's epoxy molded DIP 14 Series offers a variety of contacts and schematics to meet the needs of a wide range of applications. It features the MVS2/MVS7 models designed for high reliability. The MSS2/7 DIPs are 1-Form-A relays equipped with the MYAD® all-position mounting switch. With switching up to 50 Watts and a 4000V isolation option, the DIP 14 Series is a relay package that allows for automatic insertion directly on PCBs as well as insertion into standard 14 Pin DIP sockets.

FEATURES

- All position mercury contacts on some models
- Stable contact resistance over life
- 4000 Vac input-output isolation
- Bounce free operation
- High insulation resistance
- Switching speed of 300Hz
- Long life > 1 billion operations
- Epoxy molded for automatic board processing
- FCC68 compatible (MSS2 & MSS7)

APPLICATIONS

- Automatic test equipment
- Process control
- Industrial
- Telecom
- Datacom
- High-end security systems
- Signaling
- Metering

APPROVALS

- UL approval (DSS7 & PRMA)
- EN 60950 certified (MVS7, DSS7 & MSS7)
- CSA approval (PRMA)

RATINGS (@ 25° C)

Parameter	Min	Typ	Max	Unit
Switching Voltage				
PRMA/PRME/DSS7			200	Volts
PRMA Form C			100	Volts
MSS2/MSS7			500	Volts
MVS2/MVS7			1000	Volts
Switching Current				
PRMA/PRME/DSS7			0.5	Amps
PRMA Form C			0.25	Amps
MSS2/MSS7/MVS2/MVS7			2	Amps
Carry Current				
PRMA/PRME/DSS7			2	Amps
PRMA Form C			0.4	Amps
MSS2/MSS7			3	Amps
MVS2/MVS7			3	Amps
Switching Frequency				
PRMA/PRME/DSS7			500	Hz
PRMA Form C			50	Hz
MSS2/MSS7/MVS2/MVS7			200	Hz
Contact Resistance				
PRMA/PRME/DSS7			150	mΩ
PRMA Form C			200	mΩ
MSS2/MSS7/MVS2/MVS7			100	mΩ

(See detailed specifications for more information.)

DIP 14 SERIES REED RELAYS

MSS2 ■ MSS7 ■ PRMA ■ DSS7 ■ PRME ■ MVS2 ■ MVS7



SPECIFICATIONS

All parameters are at 25°C unless otherwise stated.
Operate voltage, release voltage, and coil resistance will change approximately 0.4%/°C as ambient temperature varies.

MSS2
Molded 8 Pin
All position
Wetted contacts

MSS7
Molded 4 Pin
All position
Wetted contacts

PARAMETER	CONDITIONS	SYMBOL	MIN	TYP	MAX	MIN	TYP	MAX	UNITS
Contact Ratings									
Switching Voltage	Max DC/PeakAC Resistive	VL	-	-	500	-	-	500	Volts
Switching Current	Max DC/PeakAC Resistive	IL	-	-	2	-	-	2	Amps
Carry Current	Max DC/PeakAC Resistive	Ic	-	-	3	-	-	3	Amps
Contact Rating	Max DC/PeakAC Resistive		-	-	50	-	-	50	Watts
Life Expectancy	Signal Level 1.0 V 10mA Related Loads ⁽¹⁾		-	200	-	-	200	-	x10 ⁶ Ops
Static Contact Resistance	50mV, 10mA	CR	-	40	100	-	65	100	mΩ
Dynamic Contact Resistance	.5V, 50mA at 100Hz, 1.5 msec	DCR	-	N/A	-	-	N/A	-	mΩ
Contact Material			-	Hg	-	-	Hg	-	
Hg Content			-	16	-	-	16	-	mgrams
Relay Specifications									
Insulation Resistance	Between all isolated pins at 100V, 25°C, 40% RH	IR	10 ⁸	10 ¹⁰	-	10 ⁸	10 ¹⁰	-	Ω
Capacitance	Across Open Contacts		-	1.5	2	-	1.2	2	pF
	Open Contact to Coil		-	3	4	-	3	4	pF
Dielectric Strength	Between Contacts		1400	-	-	2000	-	-	VDC/Peak AC
	Contacts to Coil	I/O	1400	-	-	5600	-	-	VDC/Peak AC
Operate Time, including bounce	At Nominal Coil Voltage 10Hz Square Wave	TOP	-	1.2	1.75	-	1.2	1.75	ms
Release Time	Zener-Diode Suppression	TREL	-	1	1.50	-	1	1.50	ms
Environmental Ratings									
Storage Temperature		TA	-40	-	+105	-40	-	+105	°C
Operating Temperature		To	-38	-	+75	-38	-	+75	°C
Soldering Temperature	Applied to pins, 5 sec. max.		-	260	-	-	260	-	°C
Vibration Resistance (Survival)	10Hz - 500Hz	G	-	-	10	-	-	10	Gs
Shock Resistance (Survival)	11±1ms, 1/2 Sine Wave	S	-	-	30	-	-	30	Gs
Weight			-	2.3	-	-	2.3	-	grams

(1) Refer to life graphs

SPECIFICATIONS

All parameters are at 25°C unless otherwise stated.
Operate voltage, release voltage, and coil resistance will change approximately 0.4%/°C as ambient temperature varies.

PRMA
Molded 8 Pin
Form-C
Dry Reed

PRMA
Molded 8 Pin
Form-A&B
Dry Reed

PARAMETER	CONDITIONS	SYMBOL	MIN	TYP	MAX	MIN	TYP	MAX	UNITS
Contact Ratings									
Switching Voltage	Max DC/PeakAC Resistive	VL	-	-	100	-	-	200	Volts
Switching Current	Max DC/PeakAC Resistive	IL	-	-	0.25	-	-	0.5	Amps
Carry Current	Max DC/PeakAC Resistive	Ic	-	-	0.4	-	-	2	Amps
Contact Rating	Max DC/PeakAC Resistive		-	-	3	-	-	10	Watts
Life Expectancy	Signal Level 1.0V 10mA Related Loads ⁽¹⁾		-	20	-	300	500	-	x10 ⁶ Ops
Static Contact Resistance	50mV, 10mA	CR	-	-	200	-	-	150	mΩ
Dynamic Contact Resistance	.5V, 50mA at 100Hz, 1.5 msec	DCR	-	N/A	-	-	N/A	-	mΩ
Contact Material			-	Rh	-	-	Ru	-	
Relay Specifications									
Insulation Resistance	Between all isolated pins at 100V, 25°C, 40% RH	IR	10 ⁹	10 ¹⁰	-	10 ¹⁰	10 ¹²	-	Ω
Capacitance	Across Open Contacts		-	2.5	3	-	0.7	1	pF
	Open Contact to Coil		-	3	3	-	1.5	2	pF
Dielectric Strength	Between Contacts		250	-	-	250	-	-	VDC/Peak AC
	Contacts to Coil	I/O	1400	-	-	1400	-	-	VDC/Peak AC
Operate Time, including bounce	At Nominal Coil Voltage 10Hz Square Wave	TOP	-	1.5	2	-	.25	0.5	ms
Release Time	Zener-Diode Suppression	TREL	-	1.5	3	-	.25	0.5	ms
Environmental Ratings									
Storage Temperature		TA	-40	-	+105	-40	-	+105	°C
Operating Temperature		To	-40	-	+80	-40	-	+80	°C
Soldering Temperature	Applied to pins, 5 sec. max.		-	260	-	-	-	260	°C
Vibration Resistance ⁽²⁾ (Survival)	10 Hz - 500 Hz for PRMA Form A&B 5Hz - 500Hz for PRMA Form C	G	-	-	10	-	-	20	Gs
Shock Resistance (Survival)	11±1ms, 1/2 Sine Wave	S	-	-	50	-	-	100	Gs
Weight			-	1.5	-	-	1.5	-	grams

⁽¹⁾ Refer to life graphs

⁽²⁾ Use caution not to exceed vibration resistance limits while ultrasonically cleaning relays with DYAD switches. Contact SRC Devices Engineering for more details/recommendations.

DIP 14 SERIES REED RELAYS

MSS2 ■ MSS7 ■ PRMA ■ DSS7 ■ PRME ■ MVS2 ■ MVS7



SPECIFICATIONS

All parameters are at 25°C unless otherwise stated.
Operate voltage, release voltage, and coil resistance will change approximately 0.4%/°C as ambient temperature varies.

DSS7
Molded 4 Pin
Dry Reed

PRME
Molded 8 Pin
Low profile
Dry Reed

PARAMETER	CONDITIONS	SYMBOL	MIN	TYP	MAX	MIN	TYP	MAX	UNITS
Contact Ratings									
Switching Voltage	Max DC/PeakAC Resistive	VL	-	-	200	-	-	200	Volts
Switching Current	Max DC/PeakAC Resistive	IL	-	-	0.5	-	-	0.5	Amps
Carry Current	Max DC/PeakAC Resistive	Ic	-	-	2	-	-	2	Amps
Contact Rating	Max DC/PeakAC Resistive		-	-	10	-	-	10	Watts
Life Expectancy	Signal Level 1.0 V 10mA Related Loads ⁽¹⁾		300	500	-	300	500	-	x10 ⁶ Ops
Static Contact Resistance	50mV, 10mA	CR	-	-	150	-	-	150	mΩ
Dynamic Contact Resistance	.5V, 50mA at 100Hz, 1.5 msec	DCR	-	N/A	-	-	N/A	-	mΩ
Contact Material			-	Ru	-	-	Ru	-	
Relay Specifications									
Insulation Resistance	Between all isolated pins at 100V, 25°C, 40% RH	IR	10 ¹⁰	10 ¹²	-	10 ¹⁰	10 ¹²	-	Ω
Capacitance	Across Open Contacts		-	0.7	1	-	0.8	1	pF
Dielectric Strength	Open Contact to Coil		-	1.5	2	-	1.5	2	pF
	Between Contacts		250	-	-	250	-	-	VDC/Peak AC
Operate Time, including bounce	Contacts to Coil	I/O	5600	-	-	1000	-	-	VDC/Peak AC
	At Nominal Coil Voltage	T _{OP}	-	0.25	0.5	-	0.25	1	ms
Release Time	10Hz Square Wave Zener-Diode Suppression	T _{REL}	-	0.25	0.5	-	0.25	0.5	ms
Environmental Ratings									
Storage Temperature		T _A	-40	-	+105	-40	-	+105	°C
Operating Temperature		T _O	-40	-	+80	-40	-	+80	°C
Soldering Temperature	Applied to pins, 5 sec. max.		-	-	260	-	-	260	°C
Vibration Resistance ⁽²⁾ (Survival)	5Hz - 500Hz	G	-	-	20	-	-	20	Gs
Shock Resistance (Survival)	11±1ms, 1/2 Sine Wave	S	-	-	100	-	-	100	Gs
Weight			-	1.5	-	-	1.5	-	grams

(1) Refer to life graphs

(2) Use caution not to exceed vibration resistance limits while ultrasonically cleaning relays with DYAD switches. Contact SRC Devices Engineering for more details/recommendations.

SPECIFICATIONS

All parameters are at 25°C unless otherwise stated.
Operate voltage, release voltage, and coil resistance will change approximately 0.4%/°C as ambient temperature varies.

MVS2
8 Pin DIP
Wetted Contacts⁽³⁾

MVS7
4 Pin DIP
Wetted Contacts⁽³⁾

PARAMETER	CONDITIONS	SYMBOL	MIN	TYP	MAX	MIN	TYP	MAX	UNITS
Contact Ratings									
Switching Voltage	Max DC/PeakAC Resistive	VL	-	-	1000 ⁽¹⁾	-	-	1000 ⁽¹⁾	Volts
Switching Current	Max DC/PeakAC Resistive	IL	-	-	2	-	-	2	Amps
Carry Current	Max DC/PeakAC Resistive	Ic	-	-	3	-	-	3	Amps
Contact Rating	Max DC/PeakAC Resistive		-	-	50	-	-	50	Watts
Life Expectancy	Signal Level 1.0 V 10mA		1000	-	-	1000	-	-	x10 ⁶ Ops
	50V, 1A		-	2	-	-	2	-	x10 ⁶ Ops
	500V, 100mA Related Loads ⁽²⁾		-	50	-	-	50	-	x10 ⁶ Ops
Static Contact Resistance	50mV, 10mA	CR	-	-	100	-	-	100	mΩ
Contact Material			-	Hg	-	-	Hg	-	
Hg Content			-	40	-	-	40	-	mgrams
Relay Specifications									
Insulation Resistance	Between all isolated pins at 100V, 25°C, 40% RH	IR	10 ¹⁰	10 ¹²	-	10 ¹⁰	10 ¹²	-	Ω
Capacitance	Across Open Contacts		-	0.7	-	-	0.7	-	pF
	Upper Contact to Coil		-	1.2	-	-	1.5	-	pF
	Closed Contact to Coil		-	3.2	-	-	2.5	-	pF
Dielectric Strength	Open Contacts		1400	-	-	2000	-	-	VDC/Peak AC
	Contacts to Coil	I/O	1400	-	-	5600	-	-	VDC/Peak AC
Operate Time	At Nominal Coil Voltage 10Hz Square Wave	T _{OP}	-	1.5	2.5	-	1.5	2.5	ms
Release Time	Zener-Diode Suppression	T _{REL}	-	1	2.5	-	1	2.5	ms
Environmental Ratings									
Storage Temperature		T _A	-40	-	+105	-40	-	+105	°C
Operating Temperature		T _O			+260			+260	°C
Soldering Temperature	Applied to pins, 5 sec. max.		-38	-	+85	-38	-	+85	°C
Vibration Resistance ⁽²⁾ (Survival)	10Hz - 500Hz	G	-	-	10	-	-	10	Gs
Shock Resistance (Survival)	11±1ms, 1/2 Sine Wave	S	-	-	30	-	-	30	Gs
Weight			-	2.1	-	-	2.1	-	grams

⁽¹⁾ Current limited up to 5mA, minimum 20 million operations; for further information, consult factory

⁽²⁾ Refer to life graphs

⁽³⁾ Relay contains mercury wetted contacts and must be mounted vertically. Pin 1 is up.

DIP 14 SERIES REED RELAYS

MSS2 ■ MSS7 ■ PRMA ■ DSS7 ■ PRME ■ MVS2 ■ MVS7



COIL SPECIFICATIONS

	Contact Form	Coil Voltage			Coil Resistance			Operate Voltage			Release Voltage			Nominal Input Power		
Units		Volts			Ω			Volts			Volt			mW		
Conditions					+/- 10% (25°C)			Must operate by (25°C)			Must release by (25°C)					
Part #		Min	Typ	Max	Min	Typ	Max	Min	Typ	Max	Min	Typ	Max	Min	Typ	Max
MSS2 1A05	1-Form-A		5	11	126	140	154			3.75	0.5					179
MSS2 1A12	1-Form-A		12	21	450	500	550			9	1					288
MSS2 1A24	1-Form-A		24	44	1935	2150	2365			18	2					268
MSS7 1A05	1-Form-A		5	11	126	140	154			3.75	0.5					179
MSS7 1A12	1-Form-A		12	21	450	500	550			9	1					288
MSS7 1A24	1-Form-A		24	43	1935	2150	2365			18	2					268
PRMA 1A05	1-Form-A		5	21	450	500	550			3.75	0.8					50
PRMA 1A12	1-Form-A		12	30	900	1000	1100			9	1					144
PRMA 1A24	1-Form-A		24	44	1935	2150	2365			18	2					268
PRMA 1B05	1-Form-B		5	6	450	500	550			3.75	0.8					50
PRMA 1B12	1-Form-B		12	14.5	900	1000	1100			9	1					144
PRMA 1B24	1-Form-B		24	29	1935	2150	2365			18	2					268
PRMA 1C05	1-Form-C		5	12	180	200	220			3.75	0.8					125
PRMA 1C12	1-Form-C		12	18	450	500	550			9	1					288
PRMA 1C24	1-Form-C		24	32	1935	2150	2365			18	2					268
PRMA 2A05	2-Form-A		5	11	126	140	154			3.75	0.8					179
PRMA 2A12	2-Form-A		12	21	450	500	550			9	1					288
PRMA 2A24	2-Form-A		24	44	1935	2150	2365			18	2					268
PRMA 10037	1-Form-A		5	15	342	380	418			3.75	0.8					66
PRMA 10038	1-Form-A		12	19	477	530	583			9	1					272
PRMA 10039	1-Form-A		24	32	1800	2000	2200			18	2					288
DSS7 1A05	1-Form-A		5	21	450	500	550			3.75	0.8					50
DSS7 1A12	1-Form-A		12	30	900	1000	1100			9	1					144
DSS7 1A24	1-Form-A		24	44	1935	2150	2365			18	2					268
PRME 25005	1-Form-A		5	19	450	500	550			3.8	0.8					50
PRME 15005	1-Form-A		5	15	342	380	418			3.5	1					66
PRME 15002	1-Form-A		12	19	477	530	583			8	1					272
PRME 15003	1-Form-A		24	32	1800	2000	2200			16	2					288
MVS2 1A05(A,B)	1-Form-A		5	7	94.5	105	116			3.75	0.5					238
MVS2 1A12(A,B)	1-Form-A		12	15	450	500	550			9	1					288
MVS2 1A24(A,B)	1-Form-A		24	30	1935	2150	2365			18	2					268
MVS7 1A05(S)	1-Form-A		5	7	94.5	105	116			3.75	0.5					238
MVS7 1A12(S)	1-Form-A		12	15	450	500	550			9	1					288
MVS7 1A24(S)	1-Form-A		24	30	1935	2150	2365			18	2					268

PERFORMANCE GRAPHS

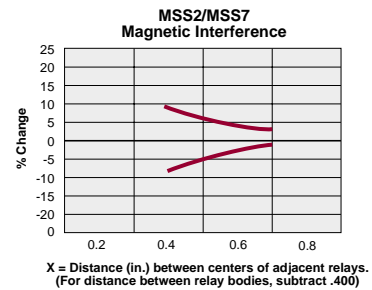
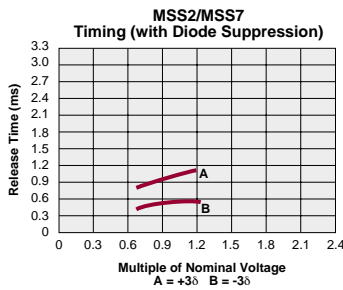
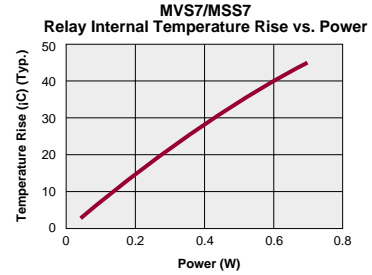
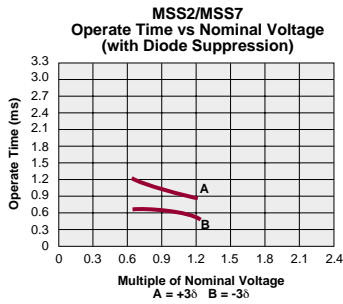
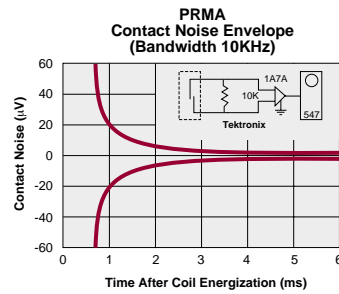
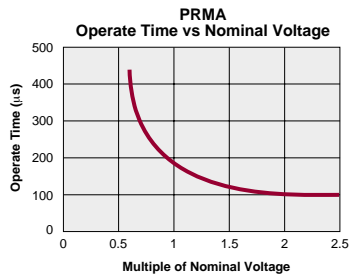
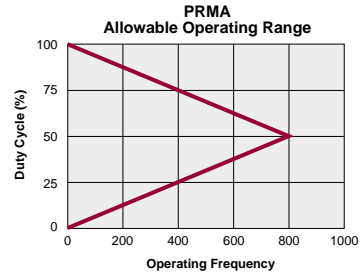
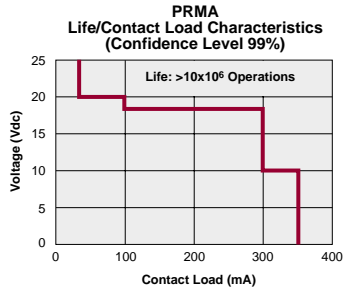

DIP 14 SERIES REED RELAYS

MSS2 ■ MSS7 ■ PRMA ■ DSS7 ■ PRME ■ MVS2 ■ MVS7



DIMENSIONS
mm
(inches)

MECHANICAL DIMENSIONS

PRMA

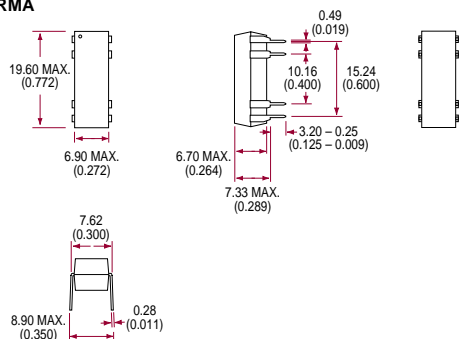

PRMA 1A

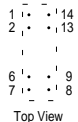

Top View

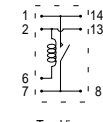

Top View

Options:
Diode - pin #2 is positive
Electrostatic shield - pin 9

PRMA 1B

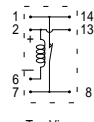

Top View

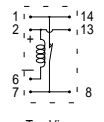

Top View

Options:
Diode - pin #2 is positive
Electrostatic shield - pin 9

PRMA 1C

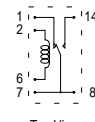

Top View

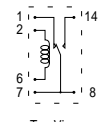

Top View

Options:
Diode - pin #2 is positive
Electrostatic shield - pin 9

PRMA 2A

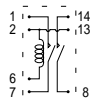

Top View

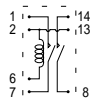

Top View

Options:
Diode - pin #2 is positive
Electrostatic shield - pin 9

PRMA 10037/10038/10039

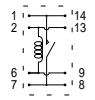

Top View

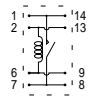

Top View

Options:
Diode - pin #2 is positive
Electrostatic shield - pin 9

MVS2/MSS2

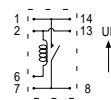

Top View

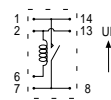

Top View

* MVS2 only must be mounted vertically with pin #1 UP.

PRME

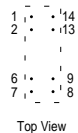
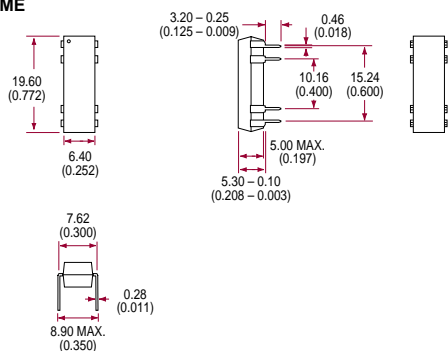

Top View

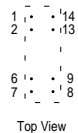

Top View

PRME

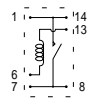

Top View

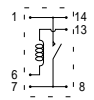

Top View

Options:
Diode - pin #13 is positive
Electrostatic shield - pin 9

DSS7

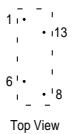
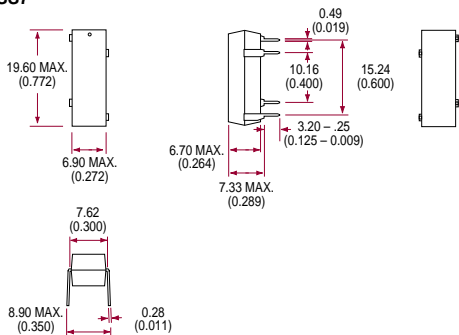

Top View

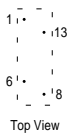

Top View

DSS7



Top View



Top View

MVS must be mounted vertically. Pin #1 is up.

ORDERING INFORMATION

A complete part number is represented by the digits below. For example, the PRMA1A05 is a model 2 PRMA relay with a 1-Form A contact form, a nominal voltage of 5V and no extra options.

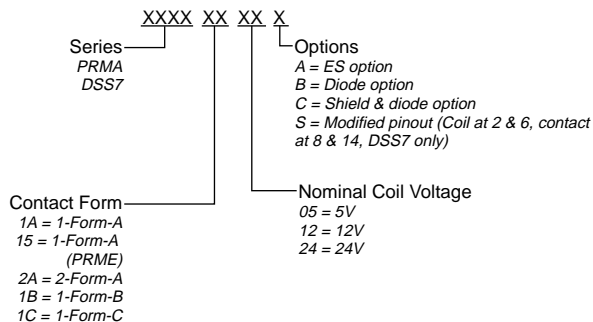

**Ordering Information
Special Schematics**

PRME 25005
 PRME 15005
 PRME 15002
 PRME 15003

PRMA 10037
 PRMA 10038
 PRMA 10039

These represent full part numbers.