

SENSITIVE GATE TRIACS

FEATURES

- VERY LOW $I_{GT} = 10\text{mA}$ max
- LOW $I_H = 15\text{mA}$ max
- BTA Family :
INSULATING VOLTAGE = $2500V_{(RMS)}$
(UL RECOGNIZED : E81734)

DESCRIPTION

The BTA/BTB04 T/D/S/A triac family are high performance glass passivated PNP devices. These parts are suitable for general purpose applications where gate high sensitivity is required. Application on 4Q such as phase control and static switching.

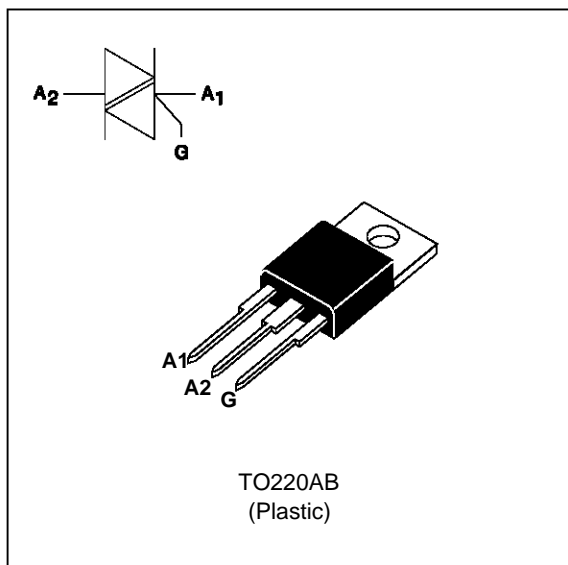

ABSOLUTE RATINGS (limiting values)

Symbol	Parameter		Value	Unit	
$I_{T(RMS)}$	RMS on-state current (360° conduction angle)	BTA	$T_c = 90^\circ\text{C}$	4	A
		BTB	$T_c = 95^\circ\text{C}$		
I_{TSM}	Non repetitive surge peak on-state current (T_j initial = 25°C)		$t_p = 8.3 \text{ ms}$	42	A
			$t_p = 10 \text{ ms}$	40	
i^2t	i^2t value		$t_p = 10 \text{ ms}$	8	A^2s
di/dt	Critical rate of rise of on-state current Gate supply : $I_G = 50\text{mA}$ $di_G/dt = 0.1\text{A}/\mu\text{s}$		Repetitive $F = 50 \text{ Hz}$	10	$\text{A}/\mu\text{s}$
			Non Repetitive	50	
T_{stg} T_j	Storage and operating junction temperature range			- 40 to + 150 - 40 to + 110	$^\circ\text{C}$ $^\circ\text{C}$
T_l	Maximum lead temperature for soldering during 10 s at 4.5 mm from case			260	$^\circ\text{C}$

Symbol	Parameter	BTA / BTB04-			Unit
		400 T/D/S/A	600 T/D/S/A	700 T/D/S/A	
V_{DRM} V_{RRM}	Repetitive peak off-state voltage $T_j = 110^\circ\text{C}$	400	600	700	V

THERMAL RESISTANCES

Symbol	Parameter	Value	Unit
Rth (j-a)	Junction to ambient	60	°C/W
Rth (j-c) DC	Junction to case for DC	BTA	4.4
		BTB	3.2
Rth (j-c) AC	Junction to case for 360° conduction angle (F= 50 Hz)	BTA	3.3
		BTB	2.4

GATE CHARACTERISTICS (maximum values)

$P_G (AV) = 1W$ $P_{GM} = 40W$ ($t_p = 20 \mu s$) $I_{GM} = 4A$ ($t_p = 20 \mu s$) $V_{GM} = 16V$ ($t_p = 20 \mu s$).

ELECTRICAL CHARACTERISTICS

Symbol	Test Conditions		Quadrant		Suffix				Unit
					T	D	S	A	
I _{GT}	V _D =12V (DC) R _L =33Ω	T _j =25°C	I-II-III	MAX	5	5	10	10	mA
			IV	MAX	5	10	10	25	
V _{GT}	V _D =12V (DC) R _L =33Ω	T _j =25°C	I-II-III-IV	MAX	1.5				V
V _{GD}	V _D =V _{DRM} R _L =3.3kΩ	T _j =110°C	I-II-III-IV	MIN	0.2				V
t _{gt}	V _D =V _{DRM} I _G = 40mA dI _G /dt = 0.5A/μs	T _j =25°C	I-II-III-IV	TYP	2				μs
I _L	I _G = 1.2 I _{GT}	T _j =25°C	I-III-IV	TYP	10	10	20	20	mA
			II		20	20	40	40	
I _H *	I _T = 100mA gate open	T _j =25°C		MAX	15	15	25	25	mA
V _{TM} *	I _{TM} = 5.5A t _p = 380μs	T _j =25°C		MAX	1.65				V
I _{DRM} I _R RRM	V _{DRM} Rated V _R RRM Rated	T _j =25°C		MAX	0.01				mA
		T _j =110°C		MAX	0.75				
dV/dt *	Linear slope up to V _D =67%V _{DRM} gate open	T _j =110°C		TYP	10	10	-	-	V/μs
				MIN	-	-	10	10	
(dV/dt) _c *	(dI/dt) _c = 1.8A/ms	T _j =110°C		TYP	1	1	5	5	V/μs

* For either polarity of electrode A₂ voltage with reference to electrode A₁.

ORDERING INFORMATION

Package	$I_T(\text{RMS})$	$V_{\text{DRM}} / V_{\text{RRM}}$	Sensitivity Specification			
	A	V	T	D	S	A
BTA (Insulated)	4	400	X	X	X	X
		600	X	X	X	X
		700	X	X	X	X
BTB (Uninsulated)	4	400	X	X	X	X
		600	X	X	X	X
		700	X	X	X	X

Fig.1 : Maximum RMS power dissipation versus RMS on-state current ($F=50\text{Hz}$).
(Curves are cut off by $(di/dt)_c$ limitation)

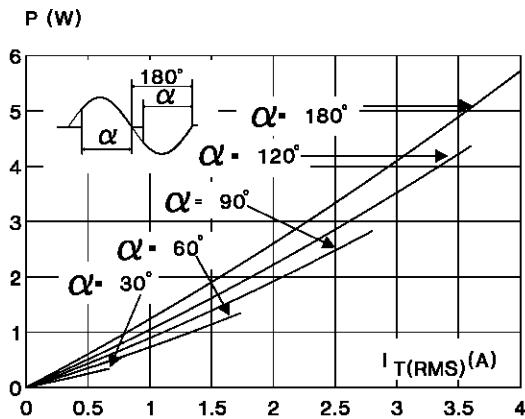

Fig.3 : Correlation between maximum RMS power dissipation and maximum allowable temperatures (T_{amb} and T_{case}) for different thermal resistances heatsink + contact (BTB).

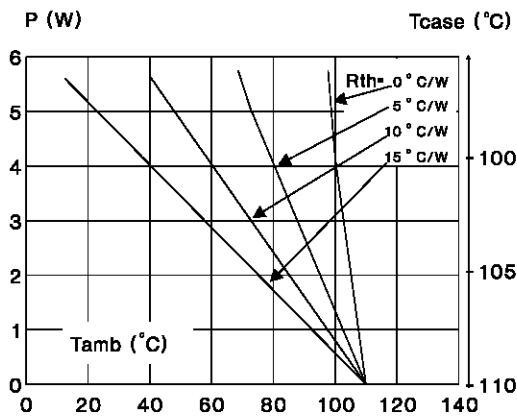

Fig.2 : Correlation between maximum RMS power dissipation and maximum allowable temperatures (T_{amb} and T_{case}) for different thermal resistances heatsink + contact (BTA).

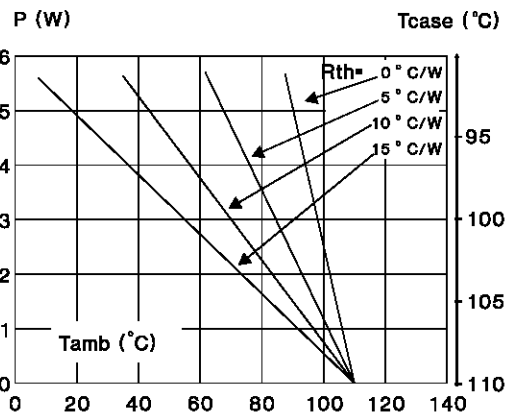

Fig.4 : RMS on-state current versus case temperature.

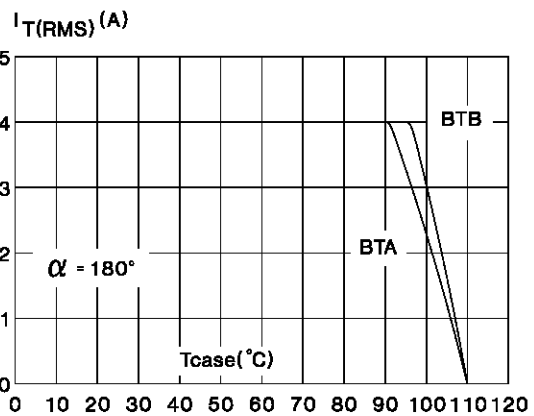

Fig.5 : Relative variation of thermal impedance versus pulse duration.

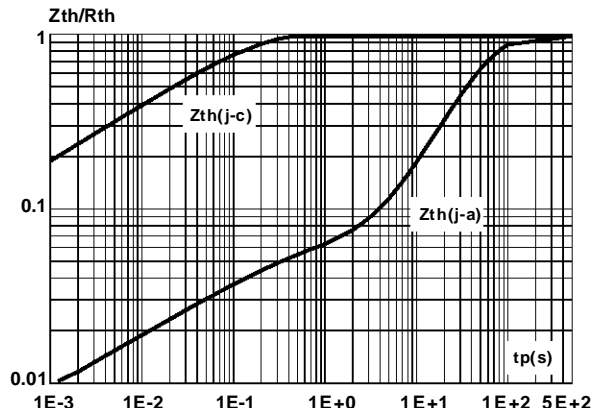

Fig.7 : Non Repetitive surge peak on-state current versus number of cycles.

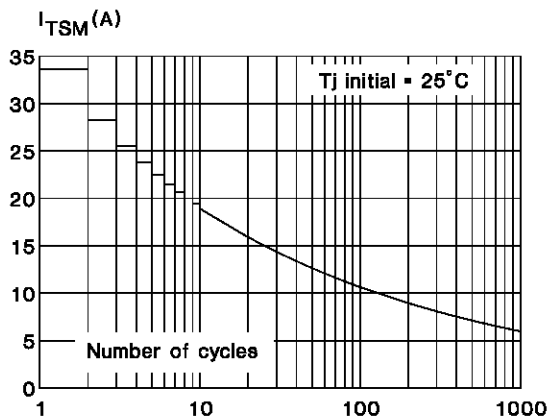

Fig.9 : On-state characteristics (maximum values).

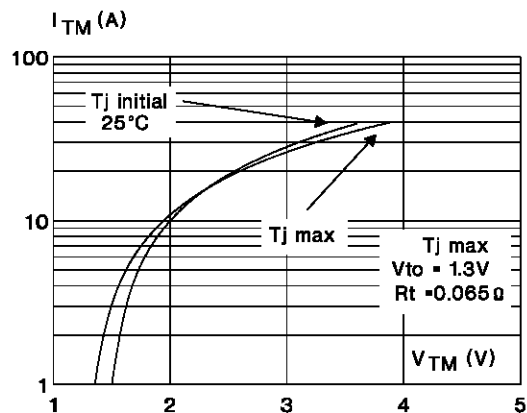

Fig.6 : Relative variation of gate trigger current and holding current versus junction temperature.

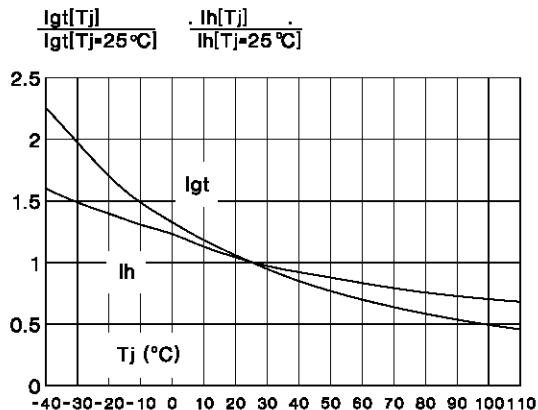
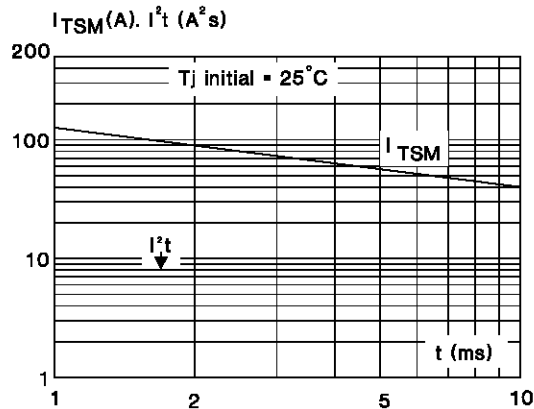
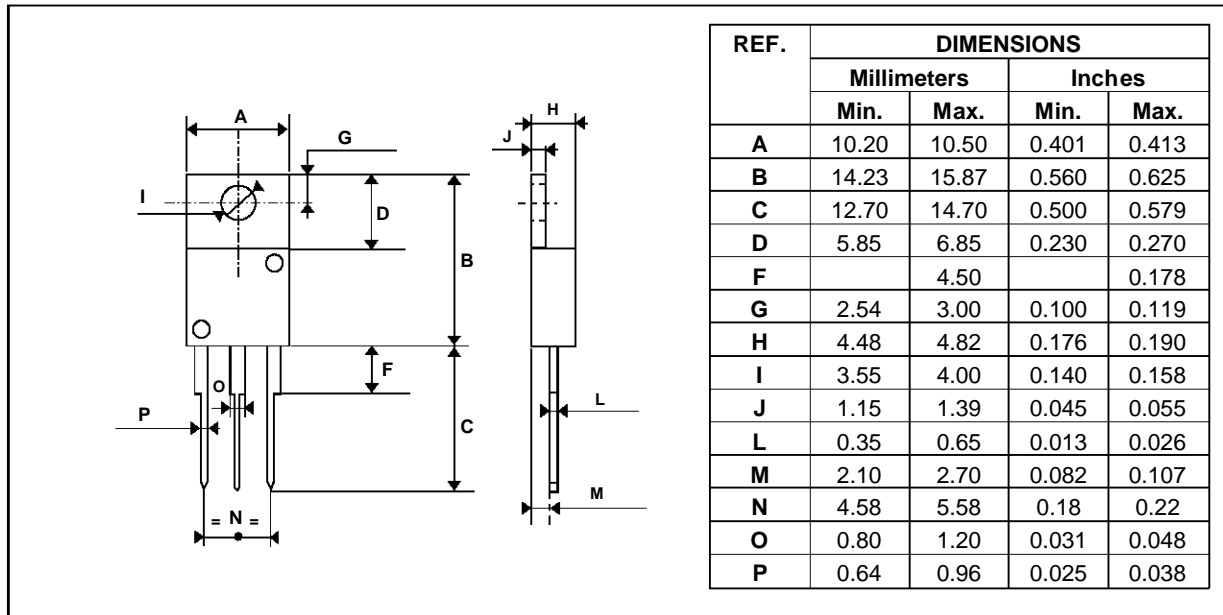

Fig.8 : Non repetitive surge peak on-state current for a sinusoidal pulse with width : $t \leq 10\text{ms}$, and corresponding value of I^2t .



PACKAGE MECHANICAL DATA

TO220AB Plastic



Cooling method : C
 Marking : type number
 Weight : 2.3 g
 Recommended torque value : 0.8 m.N.
 Maximum torque value : 1 m.N.

Information furnished is believed to be accurate and reliable. However, SGS-THOMSON Microelectronics assumes no responsibility for the consequences of use of such information nor for any infringement of patents or other rights of third parties which may result from its use. No license is granted by implication or otherwise under any patent or patent rights of SGS-THOMSON Microelectronics. Specifications mentioned in this publication are subject to change without notice. This publication supersedes and replaces all information previously supplied.

SGS-THOMSON Microelectronics products are not authorized for use as critical components in life support devices or systems without express written approval of SGS-THOMSON Microelectronics.

© 1995 SGS-THOMSON Microelectronics - All rights reserved.

SGS-THOMSON Microelectronics GROUP OF COMPANIES

Australia - Brazil - France - Germany - Hong Kong - Italy - Japan - Korea - Malaysia - Malta - Morocco - The Netherlands - Singapore - Spain - Sweden - Switzerland - Taiwan - Thailand - United Kingdom - U.S.A.