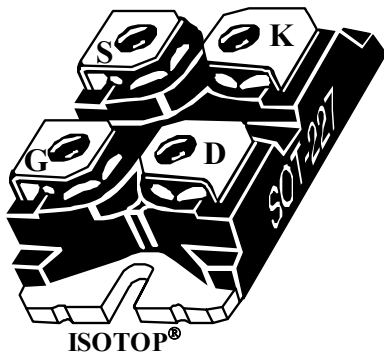
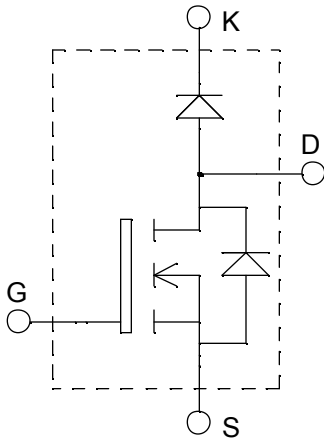

**ISOTOP[®] Boost chopper
MOSFET Power Module**
 $V_{DSS} = 100V$
 $R_{DSon} = 11m\Omega \text{ max @ } T_j = 25^\circ C$
 $I_D = 142A \text{ @ } T_c = 25^\circ C$

Application

- AC and DC motor control
- Switched Mode Power Supplies
- Power Factor Correction
- Brake switch

Features

- Power MOS V[®] MOSFETs
 - Low R_{DSon}
 - Low input and Miller capacitance
 - Low gate charge
 - Fast intrinsic diode
 - Avalanche energy rated
 - Very rugged
- ISOTOP[®] Package (SOT-227)
- Very low stray inductance
- High level of integration

Benefits

- Outstanding performance at high frequency operation
- Direct mounting to heatsink (isolated package)
- Low junction to case thermal resistance
- Very rugged
- Low profile
- RoHS Compliant

Absolute maximum ratings

| Symbol | Parameter | Max ratings | Unit |
|------------|---|--------------------|-----------|
| V_{DSS} | Drain - Source Breakdown Voltage | 100 | V |
| I_D | Continuous Drain Current | $T_c = 25^\circ C$ | 142 |
| | | $T_c = 80^\circ C$ | 106 |
| I_{DM} | Pulsed Drain current | 576 | A |
| V_{GS} | Gate - Source Voltage | ± 30 | V |
| R_{DSon} | Drain - Source ON Resistance | 11 | $m\Omega$ |
| P_D | Maximum Power Dissipation | $T_c = 25^\circ C$ | 450 |
| I_{AR} | Avalanche current (repetitive and non repetitive) | 144 | A |
| E_{AR} | Repetitive Avalanche Energy | 50 | mJ |
| E_{AS} | Single Pulse Avalanche Energy | 2500 | |
| I_{FAV} | Maximum Average Forward Current | Duty cycle=0.5 | A |
| I_{FRMS} | RMS Forward Current (Square wave, 50% duty) | $T_c = 90^\circ C$ | |
| | | | 47 |

CAUTION: These Devices are sensitive to Electrostatic Discharge. Proper Handling Procedures Should Be Followed.

All ratings @ $T_j = 25^\circ\text{C}$ unless otherwise specified

Electrical Characteristics

| Symbol | Characteristic | Test Conditions | | Min | Typ | Max | Unit |
|--------------|---------------------------------|---|---------------------------|-----|-----|-----------|------------------|
| I_{DSS} | Zero Gate Voltage Drain Current | $V_{GS} = 0\text{V}, V_{DS} = 100\text{V}$ | $T_j = 25^\circ\text{C}$ | | | 250 | μA |
| | | $V_{GS} = 0\text{V}, V_{DS} = 80\text{V}$ | $T_j = 125^\circ\text{C}$ | | | 1000 | |
| $R_{DS(on)}$ | Drain – Source on Resistance | $V_{GS} = 10\text{V}, I_D = 71\text{A}$ | | | | 11 | $\text{m}\Omega$ |
| $V_{GS(th)}$ | Gate Threshold Voltage | $V_{GS} = V_{DS}, I_D = 2.5\text{mA}$ | | 2 | | 4 | V |
| I_{GSS} | Gate – Source Leakage Current | $V_{GS} = \pm 20\text{V}, V_{DS} = 0\text{V}$ | | | | ± 100 | nA |

Dynamic Characteristics

| Symbol | Characteristic | Test Conditions | | Min | Typ | Max | Unit |
|--------------|------------------------------|--|--|-----|------|-----|------|
| C_{iss} | Input Capacitance | $V_{GS} = 0\text{V}$ | | | 8600 | | pF |
| C_{oss} | Output Capacitance | $V_{DS} = 25\text{V}$ | | | 3200 | | |
| C_{rss} | Reverse Transfer Capacitance | $f = 1\text{MHz}$ | | | 1180 | | |
| Q_g | Total gate Charge | $V_{GS} = 10\text{V}$ | | | 300 | | nC |
| Q_{gs} | Gate – Source Charge | $V_{Bus} = 50\text{V}$ | | | 95 | | |
| Q_{gd} | Gate – Drain Charge | $I_D = 50\text{A} @ T_j = 25^\circ\text{C}$ | | | 110 | | |
| $T_{d(on)}$ | Turn-on Delay Time | $V_{GS} = 15\text{V}$ | | | 16 | | ns |
| T_r | Rise Time | $V_{Bus} = 50\text{V}$ | | | 48 | | |
| $T_{d(off)}$ | Turn-off Delay Time | $I_D = 142\text{A} @ T_j = 25^\circ\text{C}$ | | | 51 | | |
| T_f | Fall Time | $R_G = 0.6\Omega$ | | | 9 | | |

Chopper diode ratings and characteristics

| Symbol | Characteristic | Test Conditions | | Min | Typ | Max | Unit | |
|-----------|----------------------------------|---|---------------------------|---------------------------|-----|------|---------------|--|
| V_F | Diode Forward Voltage | $I_F = 30\text{A}$ | | | 1.1 | 1.15 | V | |
| | | $I_F = 60\text{A}$ | | | 1.4 | | | |
| | | $I_F = 30\text{A}$ | $T_j = 125^\circ\text{C}$ | | 0.9 | | | |
| I_{RM} | Maximum Reverse Leakage Current | $V_R = 200\text{V}, T_j = 25^\circ\text{C}$ | | | | 250 | μA | |
| | | $V_R = 200\text{V}, T_j = 125^\circ\text{C}$ | | | | 500 | | |
| C_T | Junction Capacitance | $V_R = 200\text{V}$ | | | 94 | | pF | |
| t_{rr} | Reverse Recovery Time | $I_F = 1\text{A}, V_R = 30\text{V}$ $di/dt = 200\text{A}/\mu\text{s}$ | $T_j = 25^\circ\text{C}$ | | 21 | | ns | |
| | | | | $T_j = 25^\circ\text{C}$ | | 24 | | |
| | | | | $T_j = 125^\circ\text{C}$ | | 48 | | |
| I_{RRM} | Maximum Reverse Recovery Current | $I_F = 30\text{A}$ $V_R = 133\text{V}$ $di/dt = 200\text{A}/\mu\text{s}$ | $T_j = 25^\circ\text{C}$ | | 3 | | A | |
| | | | | $T_j = 125^\circ\text{C}$ | | 6 | | |
| | | | | $T_j = 25^\circ\text{C}$ | | 33 | | |
| Q_{rr} | Reverse Recovery Charge | $I_F = 30\text{A}$ $V_R = 133\text{V}$ $di/dt = 1000\text{A}/\mu\text{s}$ | $T_j = 125^\circ\text{C}$ | | 150 | | nC | |
| | | | | $T_j = 25^\circ\text{C}$ | | 31 | | |
| t_{rr} | Reverse Recovery Time | $I_F = 30\text{A}$ | | | 31 | | ns | |
| Q_{rr} | Reverse Recovery Charge | $V_R = 133\text{V}$ | | | 335 | | nC | |
| I_{RRM} | Maximum Reverse Recovery Current | $di/dt = 1000\text{A}/\mu\text{s}$ | | | 19 | | A | |

Thermal and package characteristics

| Symbol | Characteristic | Min | Typ | Max | Unit |
|----------------|--|--------|------|------|------|
| R_{thJC} | Junction to Case Thermal Resistance | MOSFET | | 0.28 | °C/W |
| | | Diode | | 1.21 | |
| R_{thJA} | Junction to Ambient (IGBT & Diode) | | | 20 | |
| V_{ISOL} | RMS Isolation Voltage, any terminal to case $t=1$ min, $I_{iso}<1$ mA, 50/60Hz | 2500 | | | V |
| T_J, T_{STG} | Storage Temperature Range | -55 | | 150 | °C |
| T_L | Max Lead Temp for Soldering: 0.063" from case for 10 sec | | | 300 | |
| Torque | Mounting torque (Mounting = 8-32 or 4mm Machine and terminals = 4mm Machine) | | | 1.5 | N.m |
| Wt | Package Weight | | 29.2 | | g |

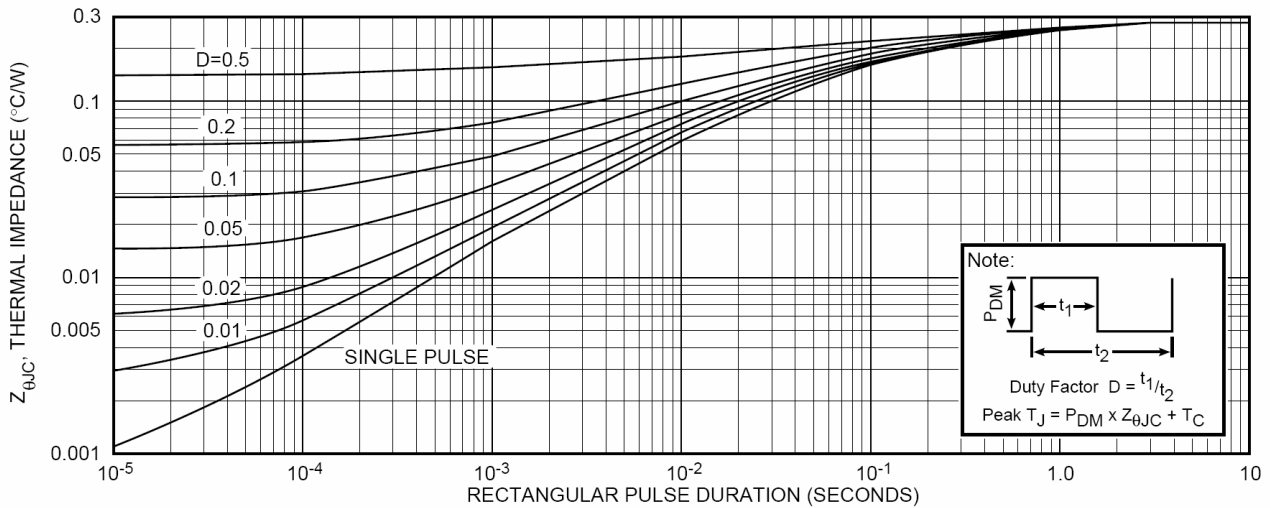
Typical MOSFET Performance Curve

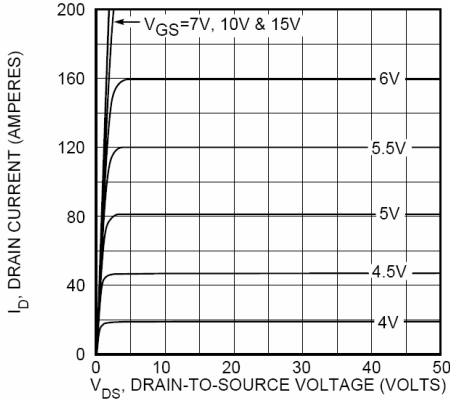

FIGURE 2, TYPICAL OUTPUT CHARACTERISTICS

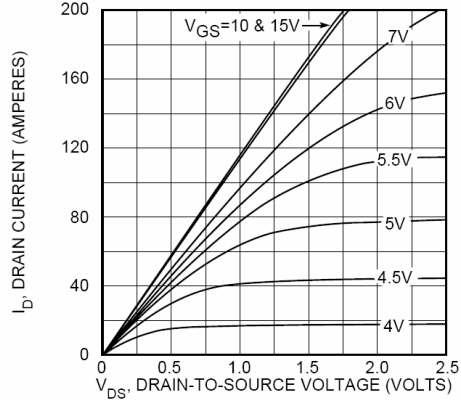

FIGURE 3, TYPICAL OUTPUT CHARACTERISTICS

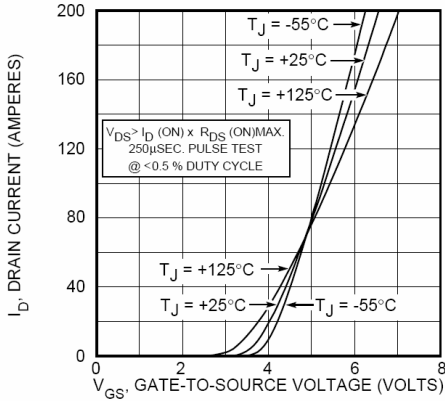

FIGURE 4, TYPICAL TRANSFER CHARACTERISTICS

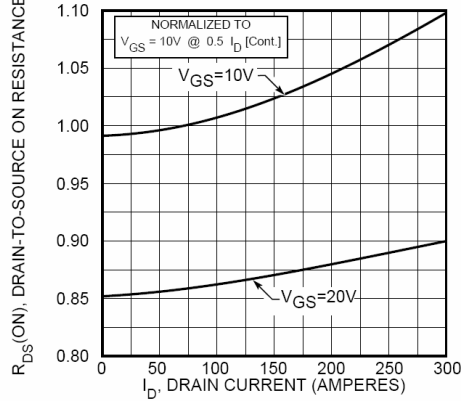

FIGURE 5, $R_{DS(ON)}$ vs DRAIN CURRENT

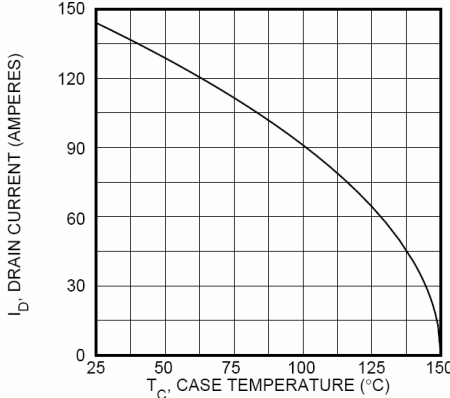

FIGURE 6, MAXIMUM DRAIN CURRENT vs CASE TEMPERATURE

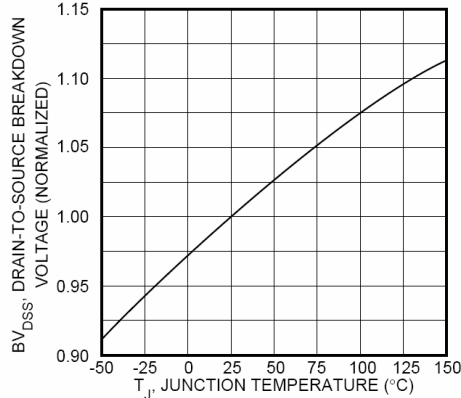

FIGURE 7, BREAKDOWN VOLTAGE vs TEMPERATURE

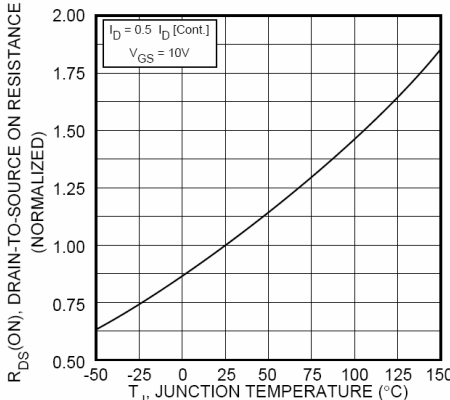

FIGURE 8, ON-RESISTANCE vs. TEMPERATURE

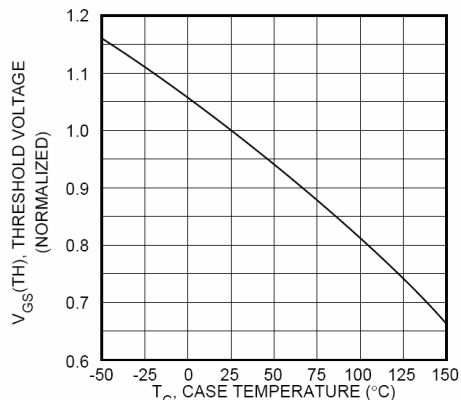

FIGURE 9, THRESHOLD VOLTAGE vs TEMPERATURE

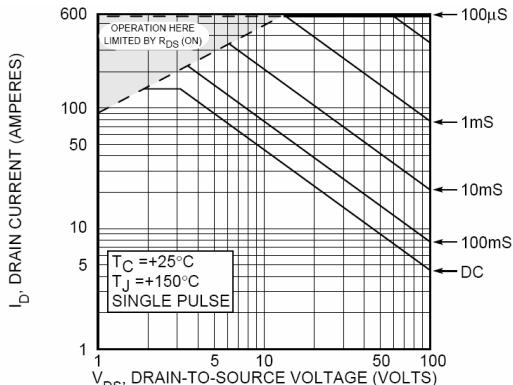

FIGURE 10, MAXIMUM SAFE OPERATING AREA

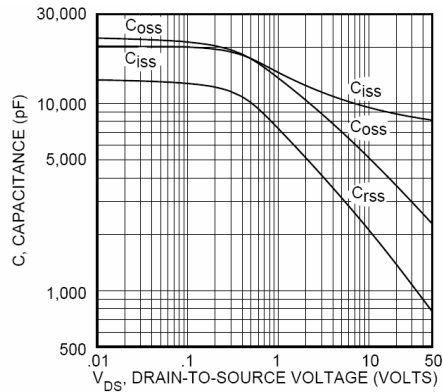

FIGURE 11, TYPICAL CAPACITANCE vs DRAIN-TO-SOURCE VOLTAGE

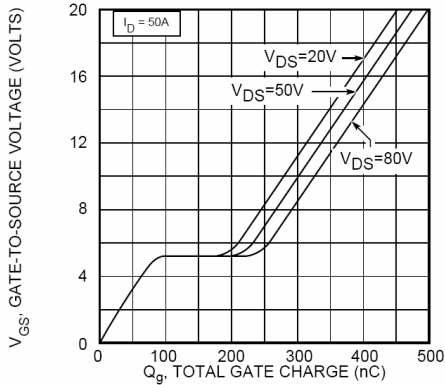

FIGURE 12, GATE CHARGES vs GATE-TO-SOURCE VOLTAGE

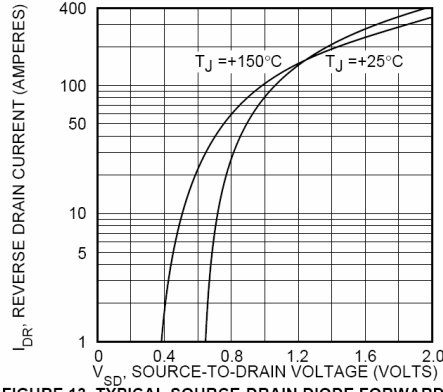

FIGURE 13, TYPICAL SOURCE-DRAIN DIODE FORWARD VOLTAGE

Typical Diode Performance Curve

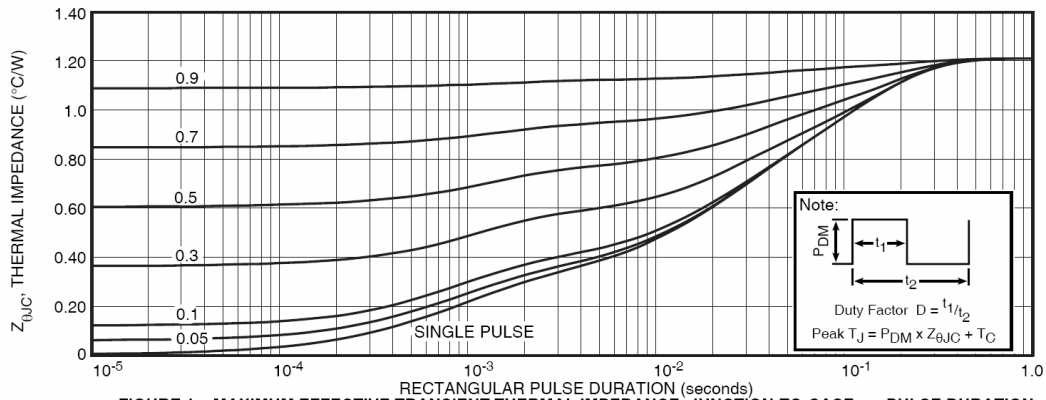

FIGURE 1a. MAXIMUM EFFECTIVE TRANSIENT THERMAL IMPEDANCE, JUNCTION-TO-CASE vs. PULSE DURATION

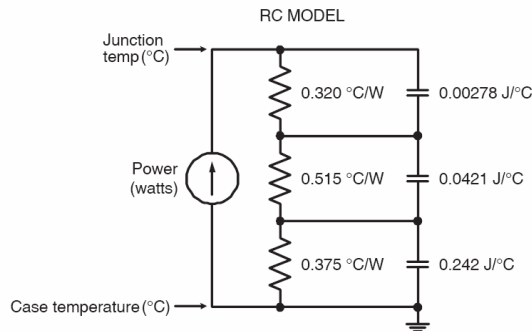

FIGURE 1b, TRANSIENT THERMAL IMPEDANCE MODEL

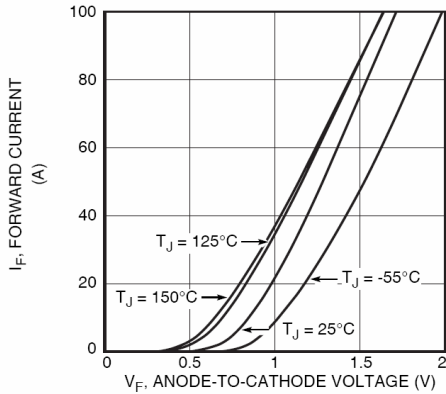

Figure 2. Forward Current vs. Forward Voltage

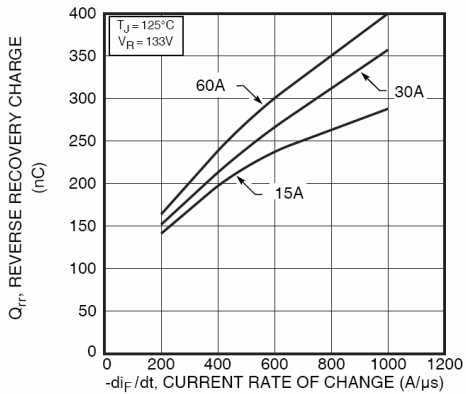

Figure 4. Reverse Recovery Charge vs. Current Rate of Change

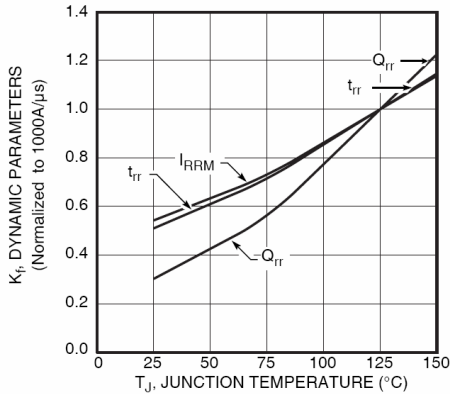

Figure 6. Dynamic Parameters vs. Junction Temperature

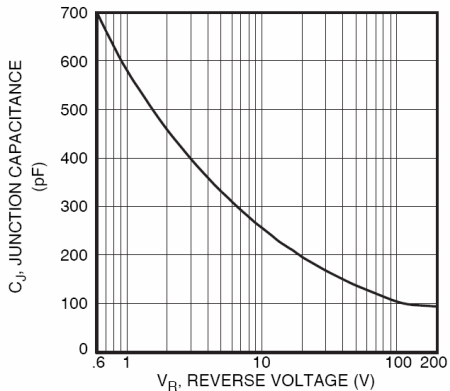

Figure 8. Junction Capacitance vs. Reverse Voltage

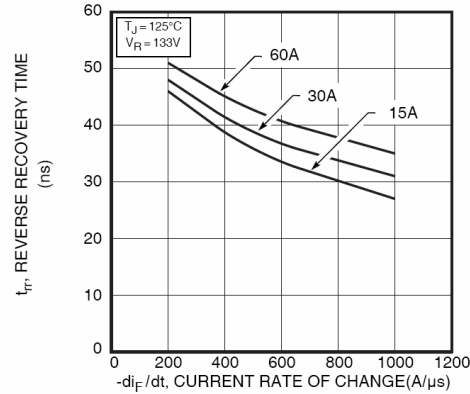

Figure 3. Reverse Recovery Time vs. Current Rate of Change

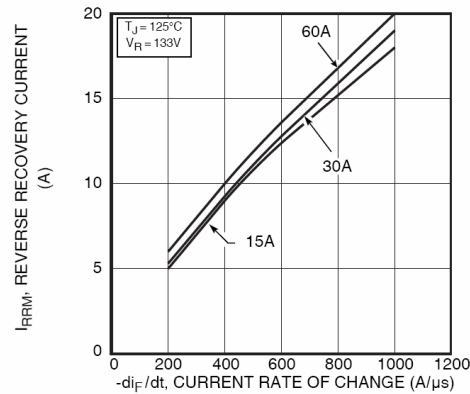

Figure 5. Reverse Recovery Current vs. Current Rate of Change

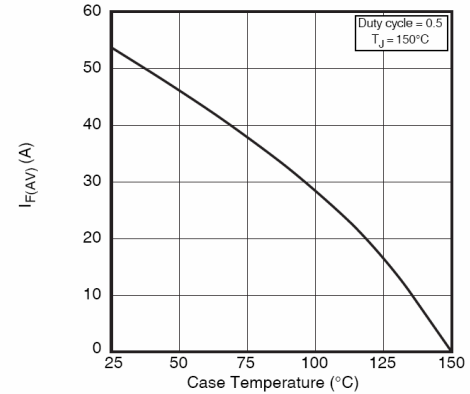

Figure 7. Maximum Average Forward Current vs. Case Temperature

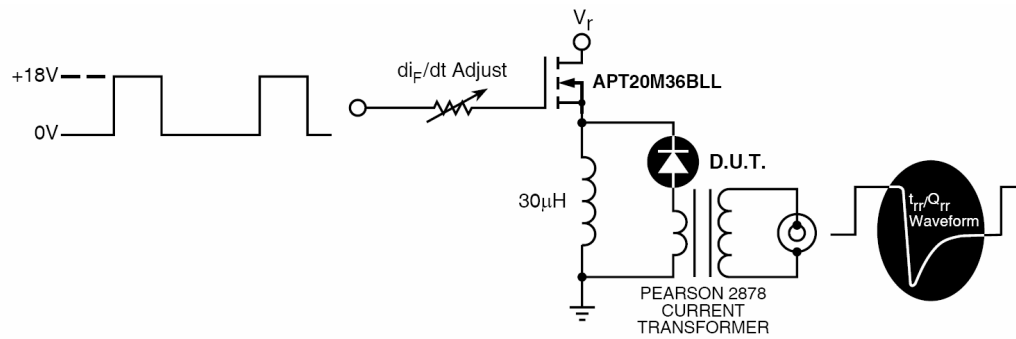

Figure 9. Diode Test Circuit

- 1 I_F - Forward Conduction Current
- 2 di_F/dt - Rate of Diode Current Change Through Zero Crossing.
- 3 I_{RRM} - Maximum Reverse Recovery Current.
- 4 t_{rr} - Reverse Recovery Time, measured from zero crossing where diode current goes from positive to negative, to the point at which the straight line through I_{RRM} and $0.25 \cdot I_{RRM}$ passes through zero.
- 5 Q_{rr} - Area Under the Curve Defined by I_{RRM} and t_{rr} .

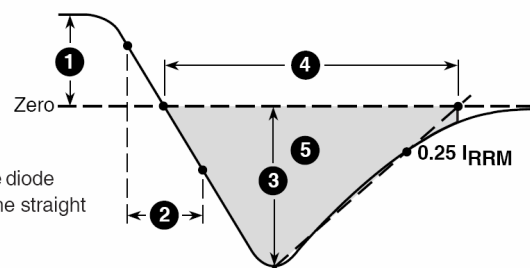
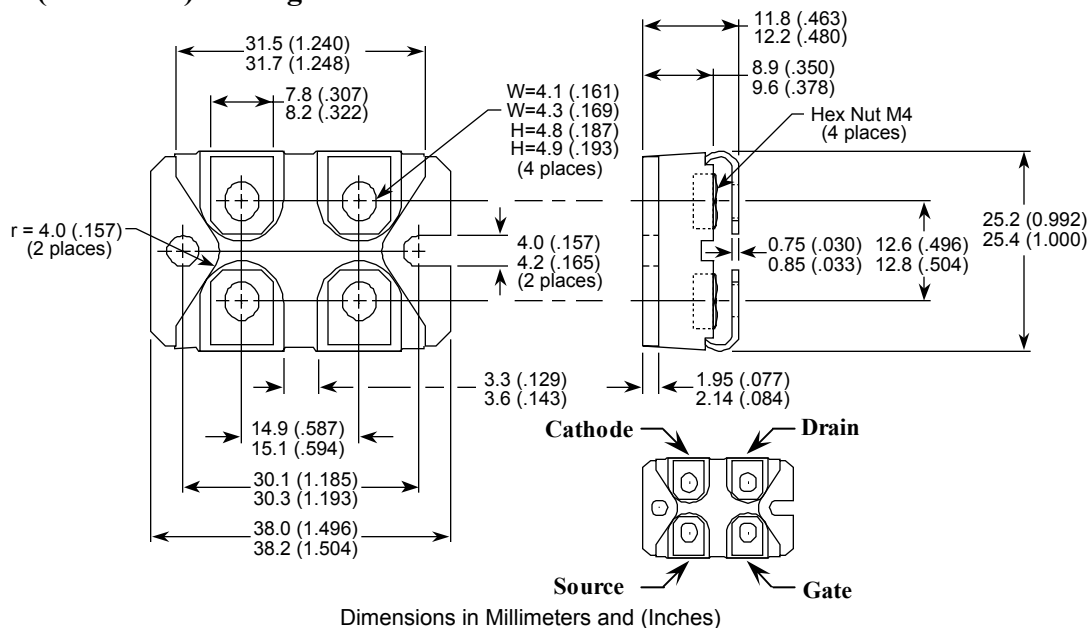

Figure 10, Diode Reverse Recovery Waveform and Definitions

SOT-227 (ISOTOP[®]) Package Outline



ISOTOP[®] is a registered trademark of ST Microelectronics NV

Microsemi reserves the right to change, without notice, the specifications and information contained herein

Microsemi's products are covered by one or more of U.S. patents 4,895,810 5,045,903 5,089,434 5,182,234 5,019,522 5,262,336 6,503,786 5,256,583 4,748,103 5,283,202 5,231,474 5,434,095 5,528,058 and foreign patents. U.S. and Foreign patents pending. All Rights Reserved.