

TURBOSWITCH ULTRA-FAST HIGH VOLTAGE DIODE
MAIN PRODUCT CHARACTERISTICS

$I_{F(AV)}$	1A
V_{RRM}	600V
t_{rr} (typ)	20ns
V_F (max)	1.5V

FEATURES AND BENEFITS

- SPECIFIC TO FREEWHEEL MODE OPERATIONS : FREEWHEEL OR BOOSTER DIODE
- ULTRA-FAST AND SOFT RECOVERY
- VERY LOW OVERALL POWER LOSSES IN BOTH THE DIODE AND THE COMPANION TRANSISTOR
- HIGH FREQUENCY OPERATIONS

DESCRIPTION

The TURBOSWITCH is a very high performance series of ultra-fast high voltage power diodes. TURBOSWITCH family drastically cuts losses in both the diode and the associated switching IGBT and MOSFET in all freewheel mode operations and is particularly suitable and efficient in motor

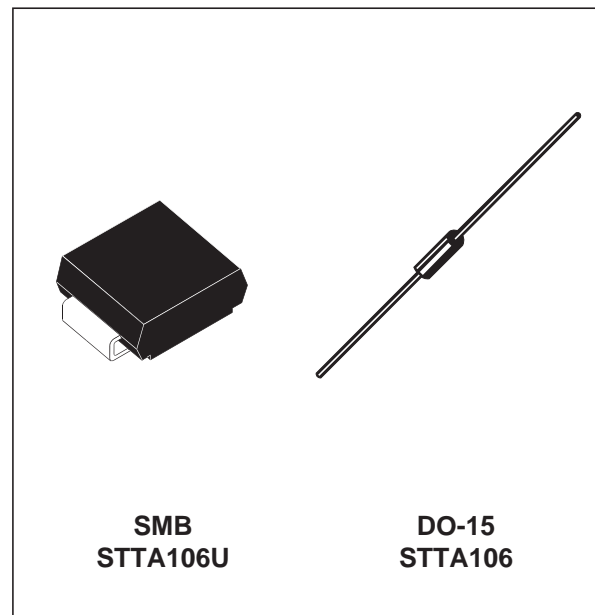

control freewheel applications and in booster diode applications in power factor control circuitries.

Available either in SMB or DO-15 axial package, these 600V devices are particularly intended for use on 240V domestic mains.

ABSOLUTE RATINGS (limiting values)

Symbol	Parameter		Value	Unit
V_{RRM}	Repetitive peak reverse voltage		600	V
$I_{F(RMS)}$	RMS forward current		6	A
I_{FRM}	Repetitive peak forward current	$t_p = 5 \mu s$ $F = 5kHz$ square	10	A
I_{FSM}	Surge non repetitive forward current	$t_p = 10 ms$ sinusoidal	25	A
T_j	Maximum operating junction temperature		125	°C
T_{stg}	Storage temperature range		- 65 to + 150	°C

TM : TURBOSWITCH is a trademark of STMicroelectronics

STTA106/U

THERMAL AND POWER DATA

Symbol	Parameter	Test conditions	Value	Unit	
$R_{th(j-l)}$	Junction to lead	SMB	23	°C/W	
	Junction to lead L=5mm	DO-15	45	°C/W	
P_1	Conduction power dissipation	$I_{F(AV)} = 0.8A$ $\delta = 0.5$ Tlead= 93°C	SMB	1.4	W
		$I_{F(AV)} = 0.8A$ $\delta = 0.5$ Tlead= 60°C	DO-15	1.4	W
P_{max}	Total power dissipation $P_{max} = P_1 + P_3$ ($P_3 = 10\% P_1$)	Tlead= 90°C	SMB	1.5	W
		Tlead= 60°C	DO-15	1.5	W

STATIC ELECTRICAL CHARACTERISTICS

Symbol	Parameter	Test conditions	Min	Typ	Max	Unit
V_F *	Forward voltage drop	$I_F = 1A$ Tj = 25°C Tj = 125°C		1.1	1.75 1.5	V
I_R **	Reverse leakage current	$V_R = 0.8 \times V_{RRM}$ Tj = 25°C Tj = 125°C		250	10 750	μA
V_{to}	Threshold voltage	$I_p < 3 \cdot I_{F(AV)}$ Tj = 125°C			1.15	V
R_d	Dynamic resistance				350	mΩ

Test pulse : * $t_p = 380 \mu s$, $\delta < 2\%$
 ** $t_p = 5 ms$, $\delta < 2\%$

To evaluate the maximum conduction losses use the following equation :
 $P = V_{to} \times I_{F(AV)} + R_d \times I_{F(RMS)}^2$

DYNAMIC ELECTRICAL CHARACTERISTICS TURN-OFF SWITCHING

Symbol	Parameter	Test conditions	Min	Typ	Max	Unit
t_{rr}	Reverse recovery time	Tj = 25°C $I_F = 0.5 A$ $I_R = 1A$ $I_{rr} = 0.25A$ $I_F = 1 A$ $di_F/dt = -50A/\mu s$ $V_R = 30V$		20	50	ns
I_{RM}	Maximum recovery current	Tj = 125°C $V_R = 400V$ $I_F = 1A$ $di_F/dt = -8 A/\mu s$ $di_F/dt = -50 A/\mu s$		1.6	0.6	A
S factor	Softness factor	Tj = 125°C $V_R = 400V$ $I_F = 1A$ $di_F/dt = -50 A/\mu s$		1.1		/

TURN-ON SWITCHING

Symbol	Parameter	Test conditions	Min	Typ	Max	Unit
t_{fr}	Forward recovery time	Tj = 25°C $I_F = 1 A$, $di_F/dt = 8 A/\mu s$			500	ns
V_{Fp}	Peak forward voltage	measured at $1.1 \times V_F$ max			10	V

Fig. 1: Conduction losses versus average current.

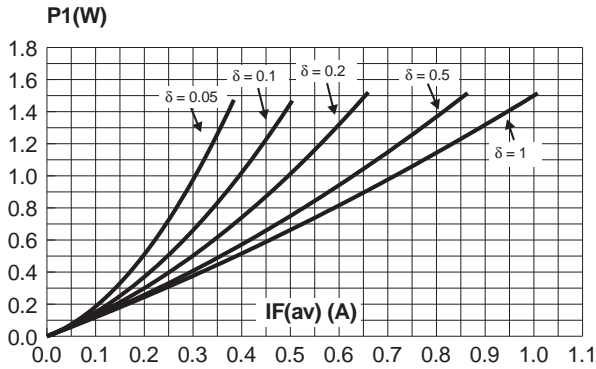

Fig. 2: Forward voltage drop versus forward current (maximum values).

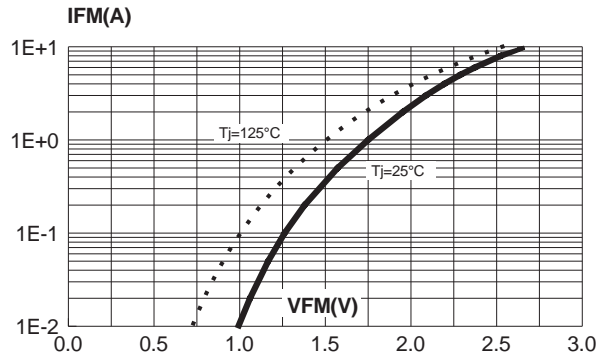

Fig. 3: Peak reverse recovery current versus dI_F/dt (90% confidence).

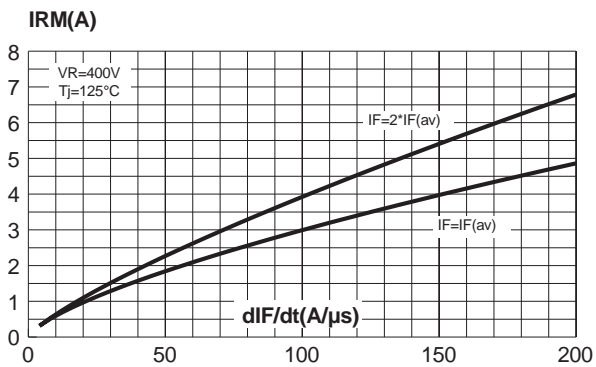

Fig. 4: Reverse recovery time versus dI_F/dt (90% confidence).

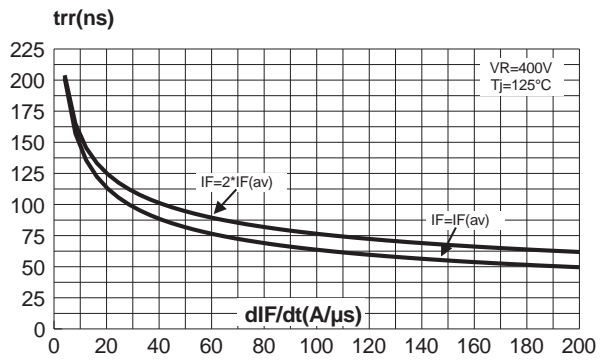

Fig. 5: Softness factor (tb/ta) versus dI_F/dt (typical values).

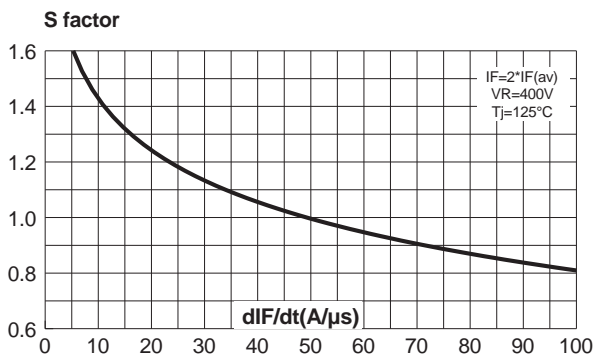

Fig. 6: Relative variation of dynamic parameters versus junction temperature (reference $T_j = 125^\circ\text{C}$). (Reference: $T_j = 125^\circ\text{C}$)

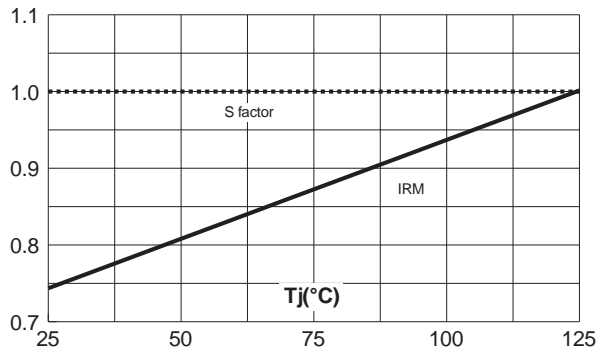

Fig. 7: Transient peak forward voltage versus dI_F/dt (90% confidence).

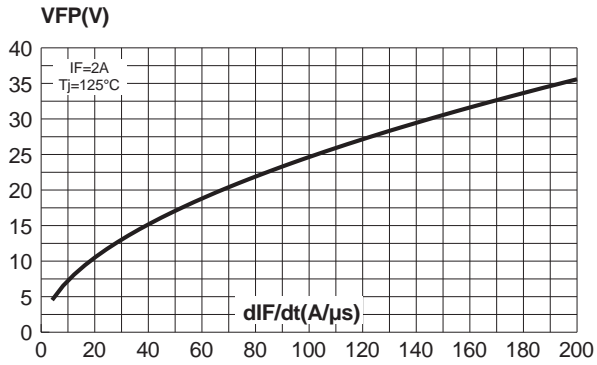

Fig. 8: Forward recovery time versus dI_F/dt (90% confidence).

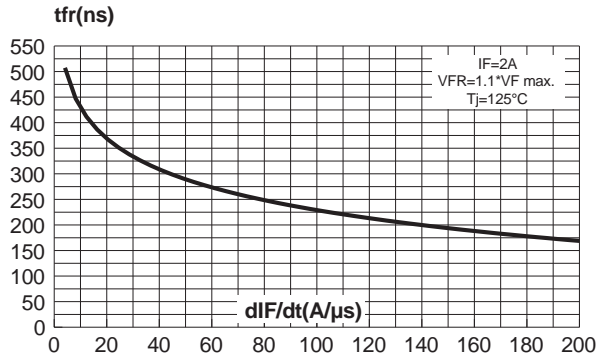
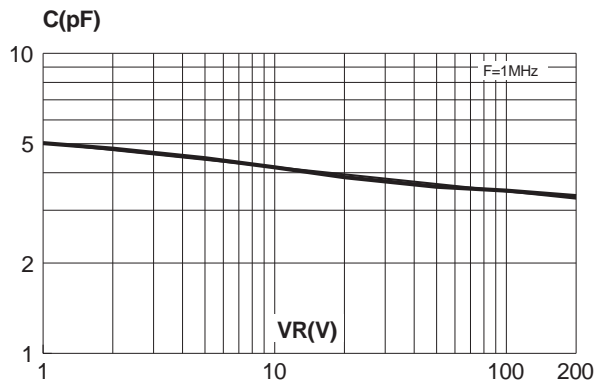

Fig. 9: Junction capacitance versus reverse voltage applied (typical values).



APPLICATION DATA

The TURBOSWITCH™ is especially designed to provide the lowest overall power losses in any “Freewheel Mode” application (see fig. A) considering both diode and companion transistor, thus optimizing the overall performance in the end application.

The way of calculating the power losses is given below :

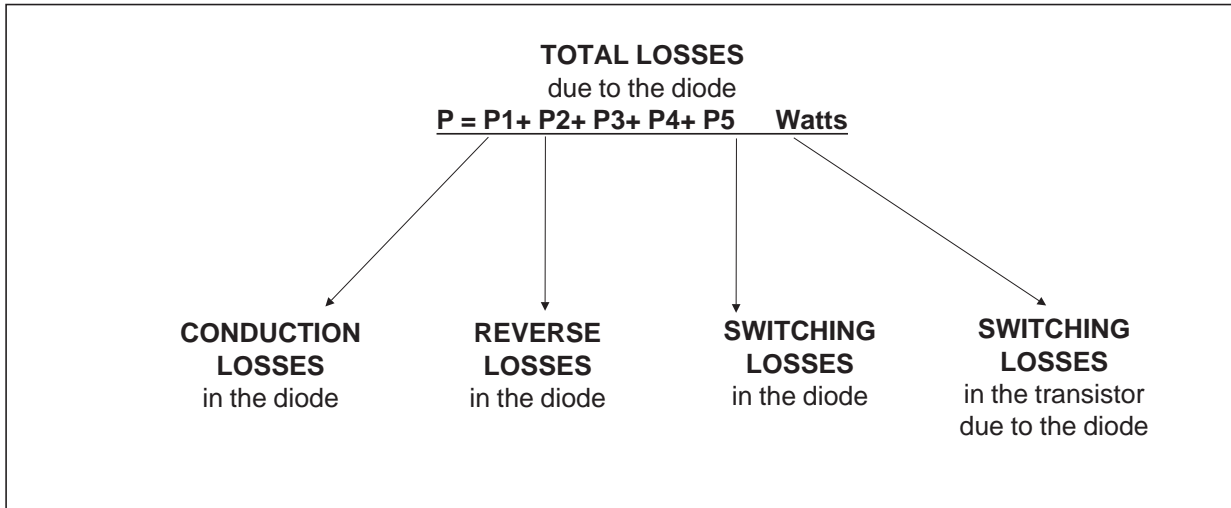
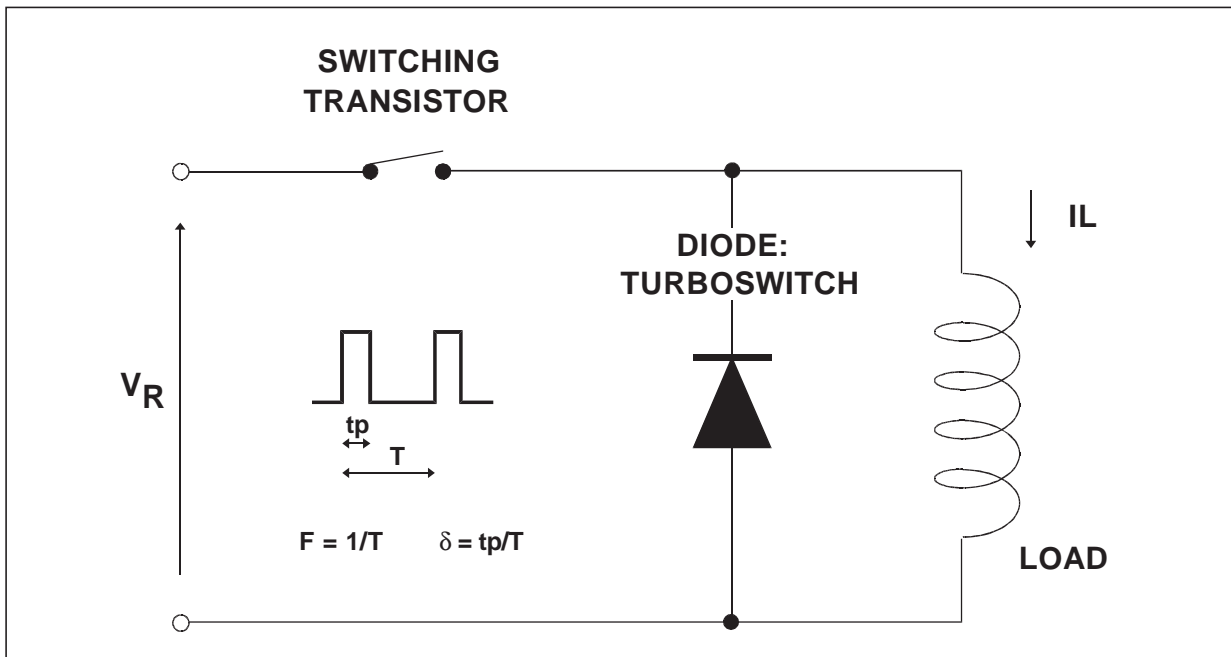
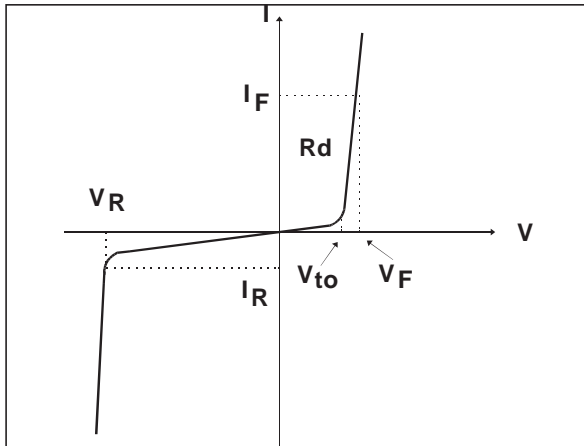

Fig. A : “FREEWHEEL” MODE



APPLICATION DATA (Cont'd)

Fig. B : STATIC CHARACTERISTICS



Conduction losses :

$$P1 = V_{to} \times I_F(AV) + R_d \times I_F^2(RMS)$$

Reverse losses :

$$P2 = V_R \times I_R \times (1 - \delta)$$

Fig. C : TURN-OFF CHARACTERISTICS

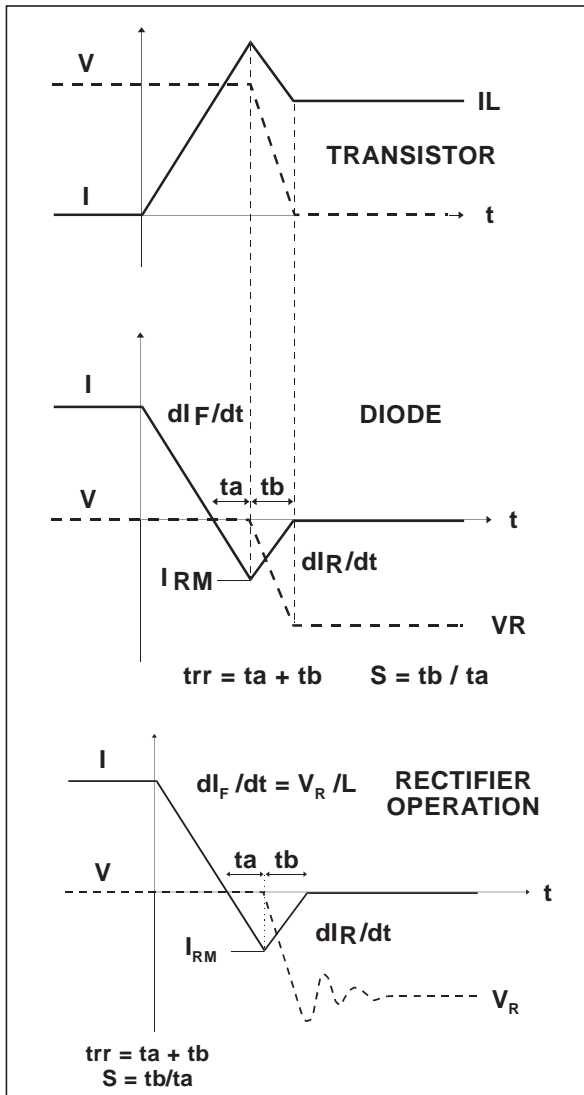

Turn-on losses :

(in the transistor, due to the diode)

$$P5 = \frac{V_R \times I_{RM}^2 \times (3 + 2 \times S) \times F}{6 \times dI_F/dt} + \frac{V_R \times I_{RM} \times I_L \times (S + 2) \times F}{2 \times dI_F/dt}$$

Turn-off losses (in the diode) :

$$P3 = \frac{V_R \times I_{RM}^2 \times S \times F}{6 \times dI_F/dt}$$

P3 and P5 are suitable for power MOSFET and IGBT

APPLICATION DATA (Cont'd)

Fig. D : TURN-ON CHARACTERISTICS

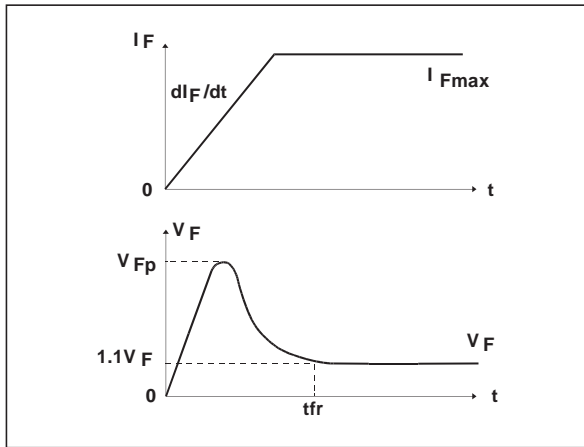

Turn-on losses :

$$P_4 = 0.4 (V_{FP} - V_F) \times I_{Fmax} \times t_{fr} \times F$$

PACKAGE MECHANICAL DATA

SMB

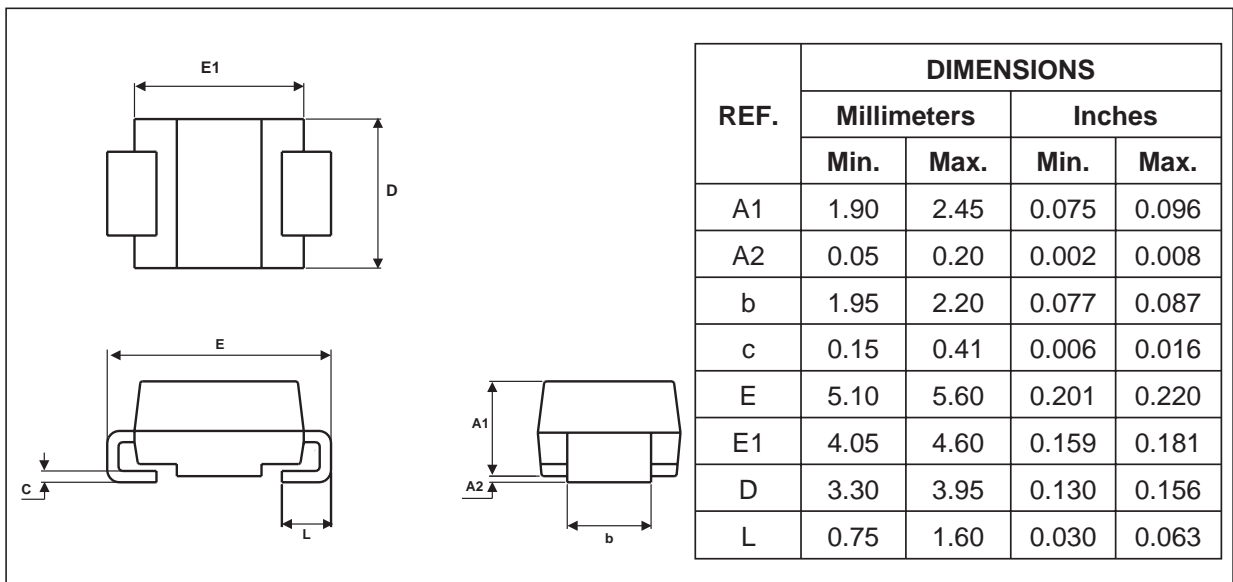

FOOTPRINT DIMENSIONS (in millimeters)

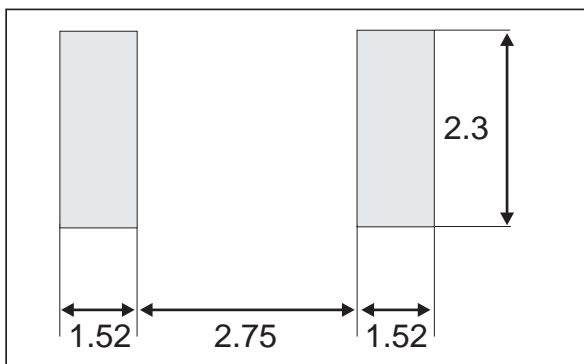

STTA106/U

PACKAGE MECHANICAL DATA

DO-15

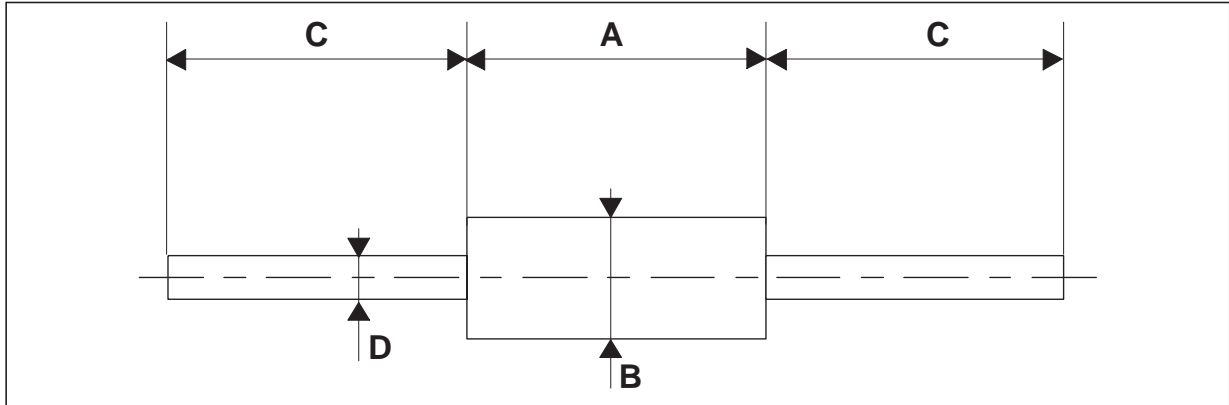

REF.	DIMENSIONS			
	Millimeters		Inches	
	Min.	Max.	Min.	Max.
A	6.05	6.75	0.238	0.266
B	2.95	3.53	0.116	0.139
C	26	31	1.024	1.220
D	0.71	0.88	0.028	0.035

MARKING

Type	Marking	Package	Weight	Base Qty	Delivery mode
STTA106U	T01	SMB	0.1 g	2500	tape & reel
STTA106	STTA106	DO-15	0.4 g	1000	Ammopack
STTA106RL	STTA106	DO-15	0.4 g	6000	tape & reel

- Band indicates cathode
- Epoxy meets UL94,V0

Information furnished is believed to be accurate and reliable. However, STMicroelectronics assumes no responsibility for the consequences of use of such information nor for any infringement of patents or other rights of third parties which may result from its use. No license is granted by implication or otherwise under any patent or patent rights of STMicroelectronics. Specifications mentioned in this publication are subject to change without notice. This publication supersedes and replaces all information previously supplied. STMicroelectronics products are not authorized for use as critical components in life support devices or systems without express written approval of STMicroelectronics.

The ST logo is a registered trademark of STMicroelectronics
 © 2001 STMicroelectronics - Printed in Italy - All rights reserved.

STMicroelectronics GROUP OF COMPANIES
 Australia - Brazil - China - Finland - France - Germany - Hong Kong - India - Italy - Japan - Malaysia
 Malta - Morocco - Singapore - Spain - Sweden - Switzerland - United Kingdom - U.S.A.

<http://www.st.com>