

coffrets métal Atlantic

■ Dimensions utiles

Portes

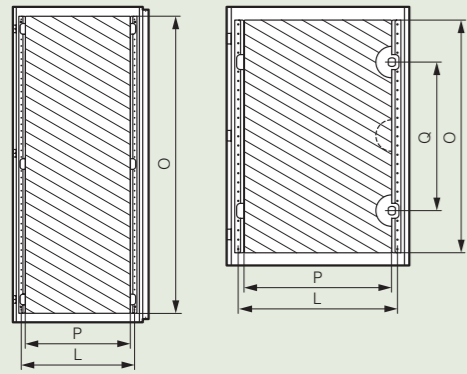

Réf.	Coffrets		Dim. utiles des portes		Position verrous Q (mm)	Entraxe porte-torons L (mm)
	Haut. (mm)	Larg. (mm)	Haut. O (mm)	Larg. P (mm)		
355 00	300	200	251	148	(1)	(3)
355 05/30	300	300	251	248	(1)	(3)
355 01	300	400	251	348	(1)	(3)
355 02/09	400	300	351	248	(1)	(3)
355 31	400	400	351	348	(1)	(3)
355 06	400	600	325	500	(1)	530
355 03/07	500	400	425	300	(1)	330
355 32	500	500	425	400	(1)	430
355 04/08	600	400	525	300	350(2)	330
355 10/20/36 354 60/66	600	600	525	500	350(2)	530
355 21/354 61	600	800	525	300 x 2	(1)	330
355 37	600	1000	525	400 x 2	(1)	430
355 12/22	700	500	625	400	400(2)	430
355 14/23/28 354 62/67	800	600	725	500	500(2)	530
355 15/24 354 63	800	800	725	700	500(2)	730
355 33/34	800	1000	725	400 x 2	(1)	430
355 17/26 354 64/68	1000	600	925	500	(1)	530
355 18/27/29 354 65	1000	800	925	700	(1)	730
355 91	1000	1000	925	400 x 2	(1)	430
355 90	1000	1200	925	500 x 2	(1)	530
355 92/96	1200	800	1125	700	(1)	730
355 93	1200	1000	1125	400 x 2	(1)	430
355 94/97	1200	1200	1125	500 x 2	(1)	530
355 98	1400	800	1325	700	(1)	730
355 95	1400	1000	1325	400 x 2	(1)	430

(1) Verrou central - (2) Verrou haut ou bas - (3) Sans porte-torons

Fixation sur porte d'un rail prof. 15 mm avec réf. 367 35

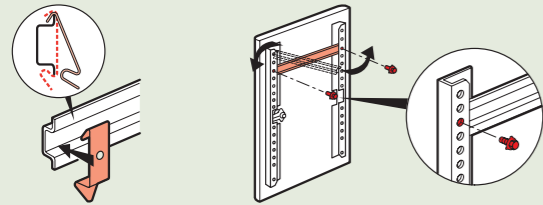

Profondeur utile

Coffrets Prof. (mm)	Sur fond de coffret	
	W (mm)	X (mm)
160	140	125
200	180	165
250	230	215
300	280	265
400	380	365

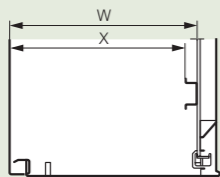

Réglage des équipements (optionnel)

Coffrets Prof. (mm)	Réf. glissières	Avec glissières			
		W mini	W maxi	X mini	X maxi
250	367 43	93	213	78	198
300	367 44	93	263	78	248
400	367 45	93	363	78	348

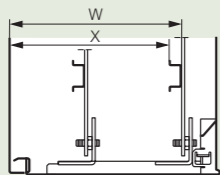

Fixation des glissières, tresse de masse

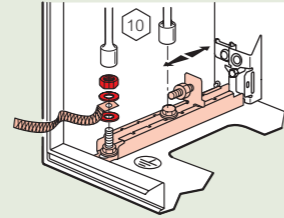

Ajours

Coffrets larg. ≤ 800 mm

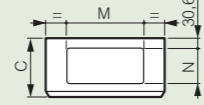

Coffrets larg. ≥ 1000 mm

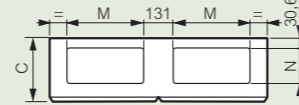

Coffrets			Dim. des ajours	
Larg. (mm)	Prof. (mm)	Prof. hors tout C (mm)	M (mm)	N (mm)
200	160	170	-	-
300	160	170	-	-
300	200	210	169	115
400	200	210	269	115
400	250	260	269	115
500	250	260	369	150
500	300	310	369	150
600	250	260	469	150
600	300	310	469	150
600	400	410	469	150
800	250	260	469	150
800	300	310	469	150
800	400	410	469	150
1000	250	260	369	150
1000	300	310	369	150
1200	300	310	469	150
1200	400	410	469	150

Associables

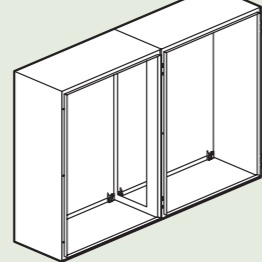

Associables d'extension

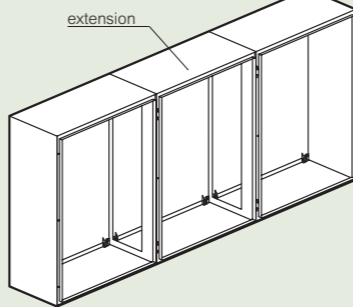

Exemples d'associations :

- 354 60 + 354 60
- 354 60 + 354 61
- 354 62 + 354 62
- 354 62 + 354 63
- 354 64 + 354 64
- 354 64 + 354 65
- etc...

Exemples d'associations avec extension :

- 354 60 + 354 66 + 354 60
- 354 60 + 354 66 + 354 61
- 354 62 + 354 67 + 354 62
- 354 62 + 354 67 + 354 63
- 354 64 + 354 68 + 354 64
- 354 65 + 354 68 + 354 65
- etc...

Dimensions de l'ajour latéral

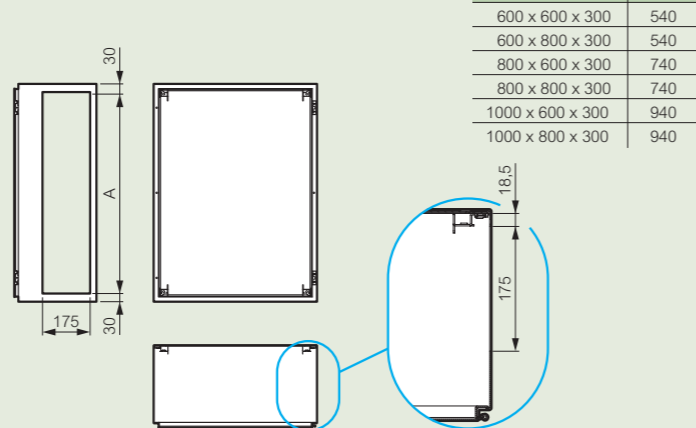

Coffrets dim. (mm)	A
600 x 600 x 300	540
600 x 800 x 300	540
800 x 600 x 300	740
800 x 800 x 300	740
1000 x 600 x 300	940
1000 x 800 x 300	940

■ Fixation des coffrets

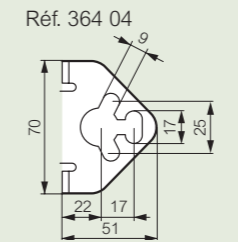
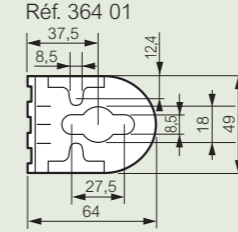
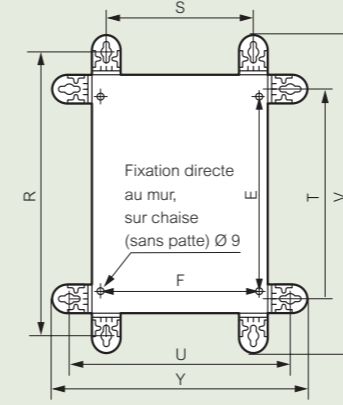

Coffrets Haut. (mm)	Larg. (mm)	Pattes verticales		Entraxe E (mm)	Pattes horizontales		Entraxe F (mm)	Hors tout 364 01		Hors tout 364 04	
		R (mm)	S (mm)		T (mm)	U (mm)		V (mm)	Y (mm)	V (mm)	Y (mm)
300	200	375	150	225	250	275	169	430	330	402	302
300	300	375	250	225	250	375	269	430	430	402	402
300	400	375	350	225	250	475	369	430	530	402	502
400	300	475	250	325	350	375	269	530	430	502	402
400	400	475	350	325	350	475	369	530	530	502	502
400	600	475	550	325	350	675	569	530	730	502	702
500	400	575	350	425	450	475	369	630	530	602	502
500	500	575	450	425	450	575	469	630	630	602	602
600	400	675	350	525	550	475	369	730	530	702	502
600	600	675	550	525	550	675	569	730	730	702	702
600	800	675	750	525	550	875	769	730	930	702	902
800	800	875	750	725	750	875	769	930	930	902	902
800	1000	875	950	725	750	1075	969	930	1130	902	1102
1000	600	1075	550	925	950	675	569	1130	730	1102	702
1000	800	1075	750	925	950	875	769	1130	930	1102	902
1000	1000	1075	950	925	950	1075	969	1130	1130	1102	1102
1000	1200	1075	1150	925	950	1275	1169	1130	1330	1102	1302
1200	800	1275	750	1125	1150	875	769	1330	930	1302	902
1200	1000	1275	950	1125	1150	1075	969	1330	1130	1302	1102
1200	1200	1275	1150	1125	1150	1275	1169	1330	1330	1302	1302
1400	800	1475	750	1325	1350	875	769	1530	930	1502	902
1400	1000	1475	950	1325	1350	1075	969	1530	1130	1502	1102

(1) Entraxes identiques pour réf. 364 01 et réf. 364 04

■ Socles

Passage trappe frontale

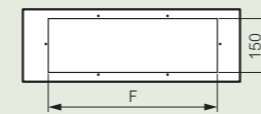

Vue de dessous - Fixation au sol

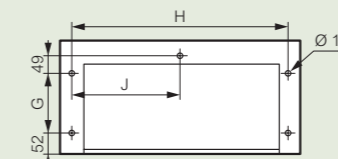

Vue de dessus - Fixation coffret

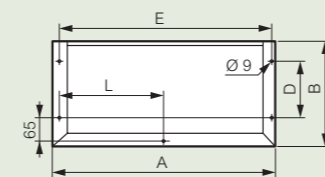

Passage trappes latérales

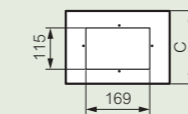

Réf.	Pour coffrets L x P (mm)	A	B	C	D	E	F	G	H	J	L
363 40	600 x 400	600	380	200	250	574	469	250	542	271	287
363 41	800 x 400	800	380	200	250	774	469	250	742	371	387
363 43	1200 x 400	1200	380	200	250	1174	469 x 2	250	1142	571	587
363 00	600 x 300	600	280	200	150	574	469	150	542	271	287
363 01	800 x 300	800	280	200	150	774	469	150	742	371	387
363 02	1000 x 300	1000	280	200	150	974	469 x 2	150	942	471	487
363 03	1200 x 300	1200	280	200	150	1174	469 x 2	150	1142	571	587

■ Fixation des toits

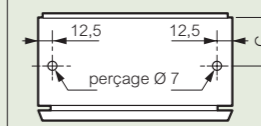

Réf.	C (mm)
365 51/52	100
365 53/54/64	125
365 56/57/61/63	150
365 60/62	200

■ Caractéristiques des plaques Cabstop IP 55

- Résistance à l'arrachement : 15 kg minimum
- Température d'utilisation : - 20 °C /+ 65 °C
- Tenue aux huiles de coupe ASTM n° 3
- Tenue au fil incandescent : 750 °C suivant IEC EN 60695-2-11

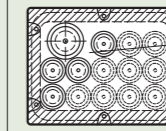

Entrée de câble Ø14 à 24 mm équivalent PE PG 21/29 ISO 25/32

Entrée de câble Ø5 à 14 mm équivalent PE PG 9/11/13/16 ISO 16/20

■ Dimensions (mm)

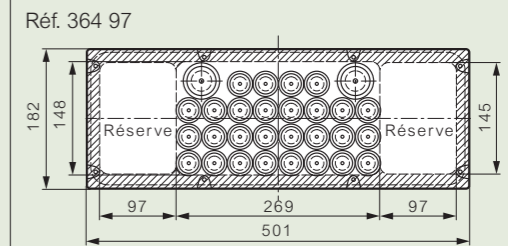
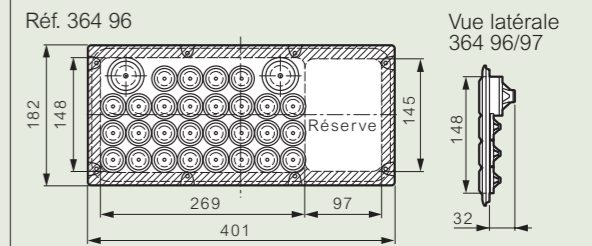
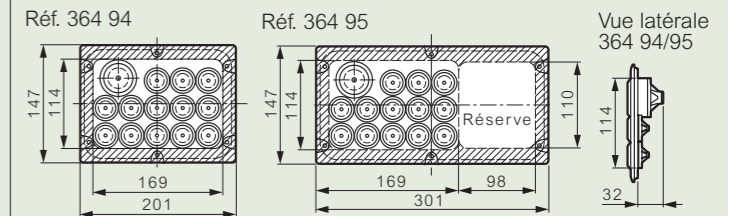

■ Kit de montage sur surface plane pour plaque Cabstop

