

Socles de connecteurs droits encastré

IP 67

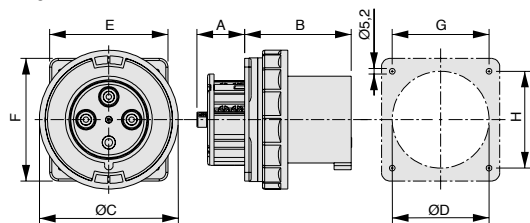

cote	63 A			125 A		
	2P+ \pm	3P+ \pm	3P+N+ \pm	2P+ \pm	3P+ \pm	3P+N+ \pm
A	24	24	24	44,5	44,5	44,5
B	89	89	89	99	99	99
C	114	114	114	129	129	129
D	75	75	75	90	90	90
E	100	100	100	110	110	110
F	107	107	107	114	114	114
G	77	77	77	90	90	90
H	85	85	85	90	90	90

Fiches et prises mobiles BT

Dimensions

Fiches mobiles droites

IP 44

cote	16 A			32 A		
	2P+ \perp	3P+ \perp	3P+N+ \perp	2P+ \perp	3P+ \perp	3P+N+ \perp
A	129	139	142	152	152	160
B	59	65	74	76	76	86
C	48	48	58	58	58	58

IP 67

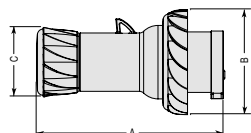

cote	16 A			32 A		
	2P+ \perp	3P+ \perp	3P+N+ \perp	2P+ \perp	3P+ \perp	3P+N+ \perp
A	129	139	142	152	152	160
B	73	81	89	95	95	102
C	48	48	58	58	58	58

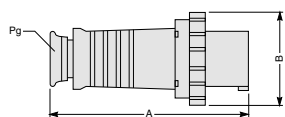

cote	63 A			125 A		
	2P+T	3P+T	3P+N+T	2P+T	3P+T	3P+N+T
A	265	265	265	325	325	325
B	110	110	110	131	131	131
Pg	36	36	36	48	48	48

Fiches mobiles droites à inversion de phase

IP 44

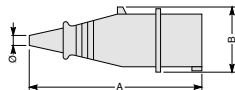

cote	16 A	
	3P+T	3P+N+T
A	145	163
B	66,5	74,5
ø	10	13

IP 67

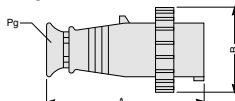

cote	16 A	
	3P+T	3P+N+T
A	139	147,5
B	77	87
Pg	Pg 16	Pg 21

Fiches mobiles coudées à 90°

IP 44

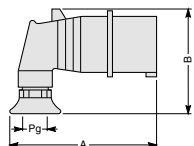

cote	16 A			32 A		
	2P+T	3P+T	3P+N+T	2P+T	3P+T	3P+N+T
A	110	115	119	141	141	141
B	91	98	105	113	113	116
Pg	16	16	16	21	21	21

IP 67

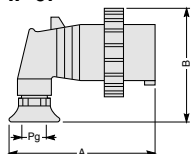

cote	16 A			32 A		
	2P+T	3P+T	3P+N+T	2P+T	3P+T	3P+N+T
A	110	115	119	141	141	141
B	91	98	105	113	113	116
Pg	16	16	16	21	21	21

Prises mobiles droites

IP 44

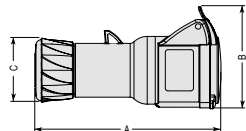

cote	16 A			32 A		
	2P+ \perp	3P+ \perp	3P+N+ \perp	2P+ \perp	3P+ \perp	3P+N+ \perp
A	140	150	153	165	165	172
B	78	88	97	98	98	106
C	48	48	58	58	58	58

IP 67

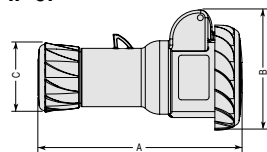

cote	16 A			32 A		
	2P+ \perp	3P+ \perp	3P+N+ \perp	2P+ \perp	3P+ \perp	3P+N+ \perp
A	142	152	155	164	164	173
B	84	87	96	99	99	104
C	48	48	58	58	58	58

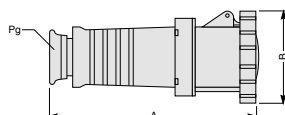

cote	63 A			125 A		
	2P+T	3P+T	3P+N+T	2P+T	3P+T	3P+N+T
A	265	265	265	325	325	325
B	110	110	110	131	131	131
Pg	36	36	36	48	48	48

Socles de prises, fiches et prises mobiles, socles de connecteurs TBT

Dimensions

Socles de prises droites encastrés

IP 44

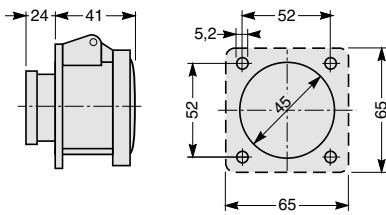

IP 67

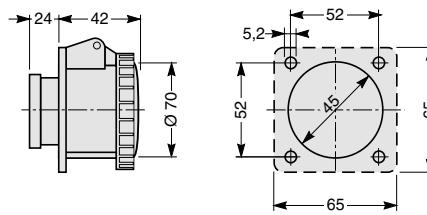

Socles de prises TBT avec transformateur de sécurité encastrés

IP 44 et IP 65

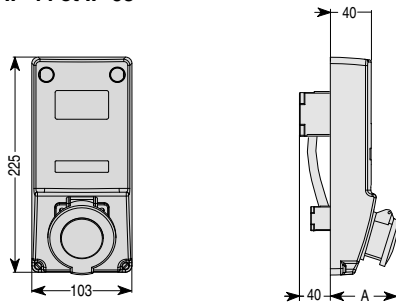

Socles de prises inclinées en saillie

IP 44

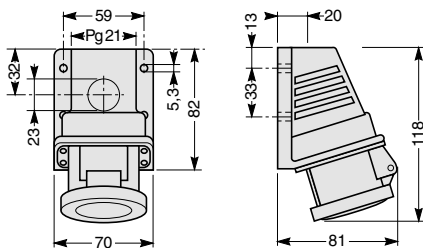

IP 67

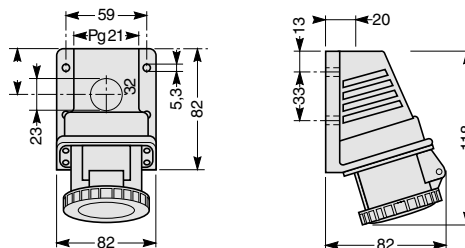

Fiches mobiles droites

IP 44

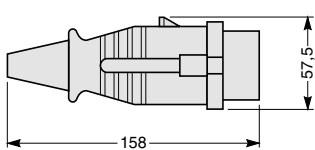

IP 67

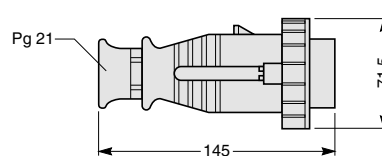

Prises mobiles droites

IP 44

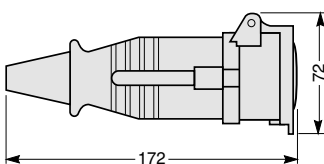

IP 67

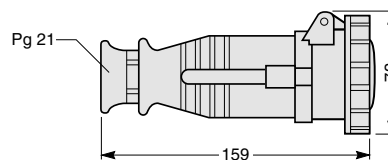

Socles de connecteurs inclinés en saillie

IP 44

