

HIGH EFFICIENCY FAST RECOVERY RECTIFIER DIODES

- VERY LOW CONDUCTION LOSSES
- NEGLIGIBLE SWITCHING LOSSES
- LOW FORWARD AND REVERSE RECOVERY TIMES
- HIGH SURGE CURRENT
- THE SPECIFICATIONS AND CURVES ENABLE THE DETERMINATION OF t_{rr} AND I_{RM} AT 100°C UNDER USERS CONDITIONS

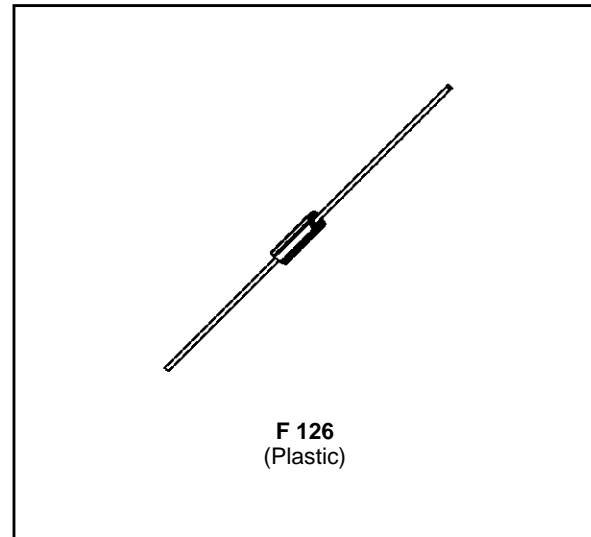

DESCRIPTION

Low voltage drop and rectifier suited for switching mode base drive and transistor circuits.

ABSOLUTE RATINGS (limiting values)

Symbol	Parameter		Value	Unit
I_{FRM}	Repetitive Peak Forward Current	$t_p \leq 20\mu s$	50	A
$I_F (AV)$	Average Forward Current*	$T_a = 90^\circ C$ $\delta = 0.5$	1.5	A
I_{FSM}	Surge non Repetitive Forward Current	$t_p = 10ms$ Sinusoidal	50	A
P_{tot}	Power Dissipation*	$T_a = 90^\circ C$	1.3	W
T_{stg} T_j	Storage and Junction Temperature Range		- 40 to + 150 - 40 to + 150	°C
T_L	Maximum Lead Temperature for Soldering during 10s at 4mm from Case		230	°C

Symbol	Parameter	BYW 100-				Unit
		50	100	150	200	
V_{RRM}	Repetitive Peak Reverse Voltage	50	100	150	200	V
V_{RSM}	Non Repetitive Peak Reverse Voltage	55	110	165	220	V

THERMAL RESISTANCE

Symbol	Parameter	Value	Unit
$R_{th(j-a)}$	Junction-ambient*	45	°C/W

* On infinite heatsink with 10mm lead length.

ELECTRICAL CHARACTERISTICS

STATIC CHARACTERISTICS

Symbol	Test Conditions		Min.	Typ.	Max.	Unit
I _R	T _j = 25°C	V _R = V _{RRM}			10	μA
	T _j = 100°C				0.5	mA
V _F	T _j = 25°C	I _F = 4.5A			1.2	V
	T _j = 100°C	I _F = 1.5A			0.85	

RECOVERY CHARACTERISTICS

Symbol	Test Conditions			Min.	Typ.	Max.	Unit
t _{rr}	T _j = 25°C V _R = 30V	I _F = 1A See figure 10	di _F /dt = - 50A/μs			35	ns
Q _{rr}	T _j = 25°C V _R ≤ 30V	I _F = 1A	di _F /dt = - 20A/μs		10		nC
t _{fr}	T _j = 25°C Measured at 1.1 x V _F	I _F = 1A	t _r = 10ns		30		ns
V _{FP}	T _j = 25°C	I _F = 1A	t _r = 10ns		5		V

To evaluate the conduction losses use the following equations:

$$V_F = 0.66 + 0.075 I_F$$

$$P = 0.06 \times I_{F(AV)} + 0.075 I_{F(RMS)}^2$$

Figure 1. Maximum average power dissipation versus average forward current.

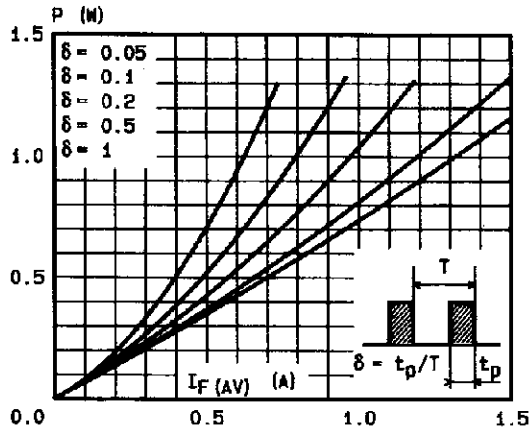

Figure 2. Average forward current versus ambient temperature.

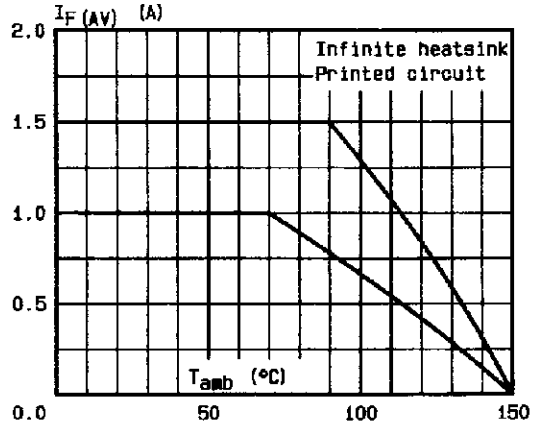
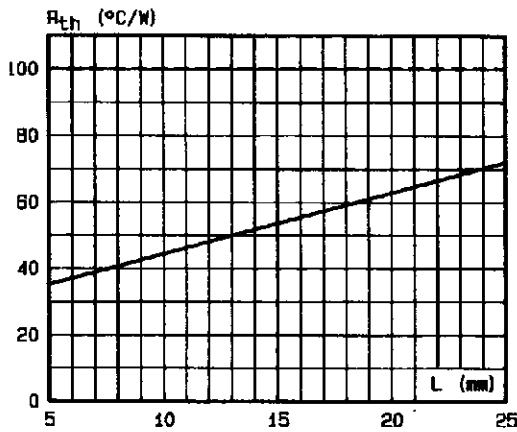

Figure 3. Thermal resistance versus lead length.



Mounting n°1 INFINITE HEATSINK Mounting n°2 PRINTED CIRCUIT

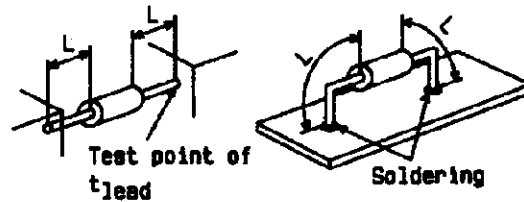

Figure 4. Transient thermal impedance junction-ambient for mounting n°2 versus pulse duration (L = 10 mm).

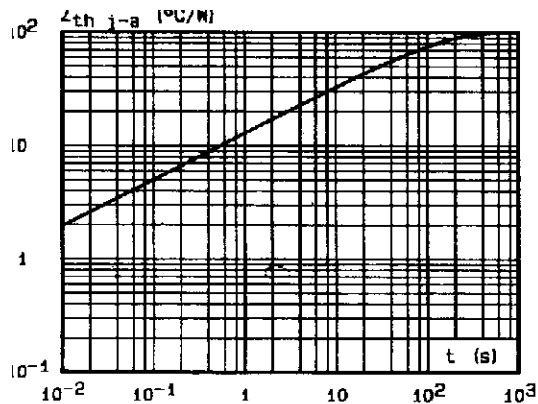

Figure 5. Peak forward current versus peak forward voltage drop (maximum values).

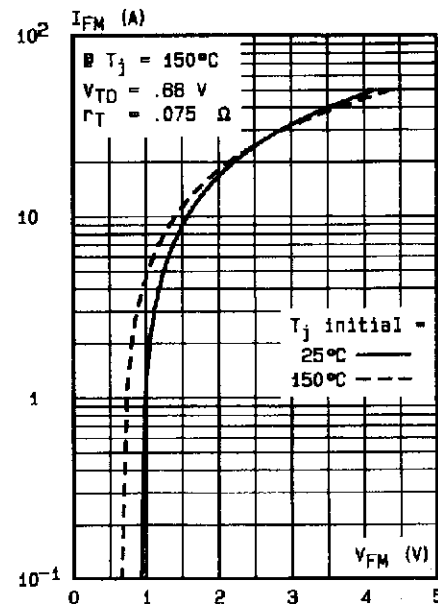

Figure 6. Capacitance versus reverse voltage applied.

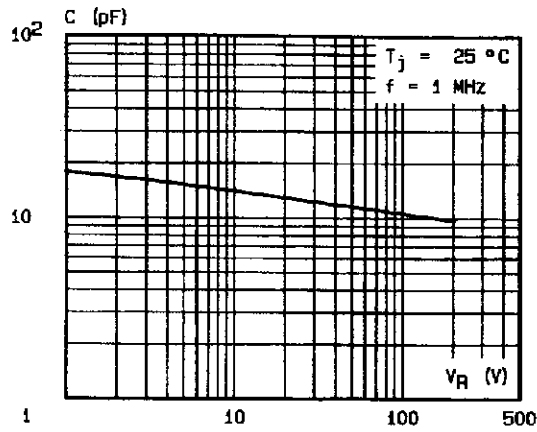

Figure 7. Recovery time versus di_F/dt .

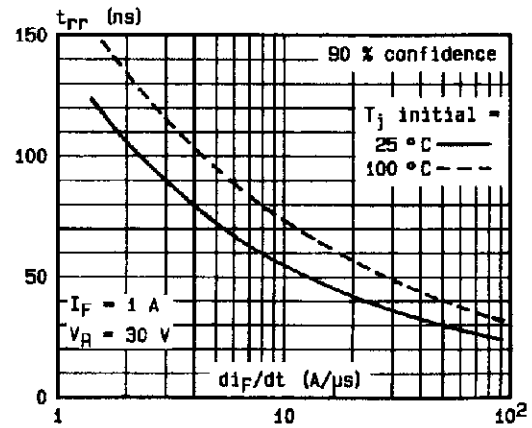

Figure 8. Peak reverse current versus di_F/dt .

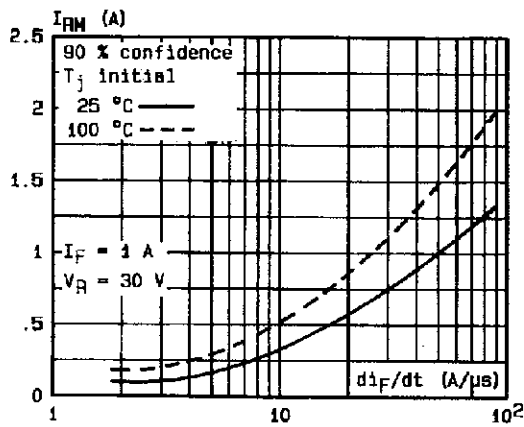

Figure 9. Dynamic parameters versus junction temperature.

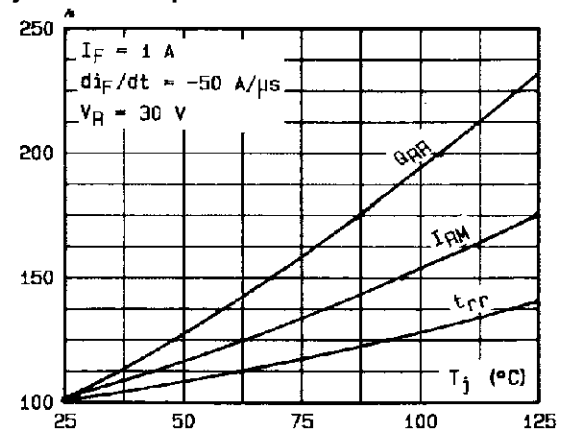
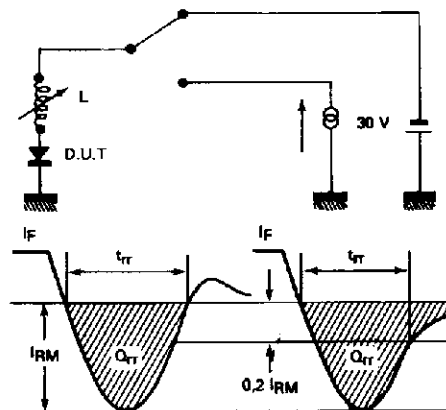
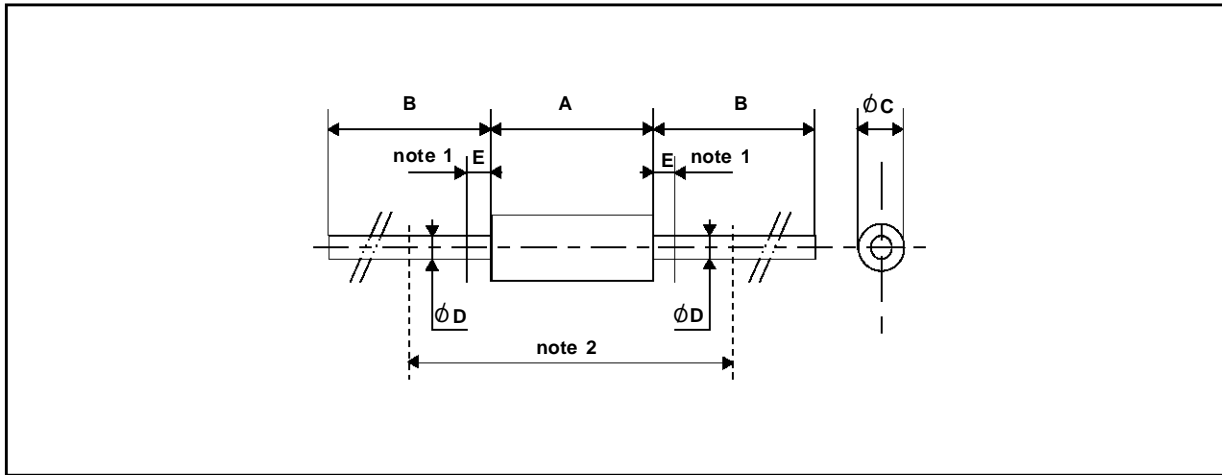

Figure 10. Measurement of t_{rr} (Fig. 7) and I_{RM} (Fig. 8).



PACKAGE MECHANICAL DATA

F 126 (Plastic)



REF.	DIMENSIONS				NOTES
	Millimeters		Inches		
	Min.	Max.	Min.	Max.	
A	6.05	6.35	0.238	0.250	1 - The lead diameter $\varnothing D$ is not controlled over zone E 2 - The minimum axial length within which the device may be placed with its leads bent at right angles is 0.59" (15 mm)
B	26		1.024		
$\varnothing C$	2.95	3.05	0.116	0.120	
$\varnothing D$	0.76	0.86	0.029	0.034	
E		1.27		0.050	

Cooling method: by convection (method A)
 Marking: type number
 Weight: 0.4g

Information furnished is believed to be accurate and reliable. However, SGS-THOMSON Microelectronics assumes no responsibility for the consequences of use of such information nor for any infringement of patents or other rights of third parties which may result from its use. No license is granted by implication or otherwise under any patent or patent rights of SGS-THOMSON Microelectronics. Specifications mentioned in this publication are subject to change without notice. This publication supersedes and replaces all information previously supplied. SGS-THOMSON Microelectronics products are not authorized for use as critical components in life support devices or systems without express written approval of SGS-THOMSON Microelectronics.

© 1994 SGS-THOMSON Microelectronics - Printed in Italy - All rights reserved.

SGS-THOMSON Microelectronics GROUP OF COMPANIES

Australia - Brazil - France - Germany - Hong Kong - Italy - Japan - Korea - Malaysia - Malta - Morocco - The Netherlands
 Singapore - Spain - Sweden - Switzerland - Taiwan - Thailand - United Kingdom - U.S.A.