

# Thyristors

## Silicon Controlled Rectifiers

... designed primarily for half-wave ac control applications, such as motor controls, heating controls and power supply crowbar circuits.

- Glass Passivated Junctions with Center Gate Fire for Greater Parameter Uniformity and Stability
- Small, Rugged, Thermowatt Constructed for Low Thermal Resistance, High Heat Dissipation and Durability
- Blocking Voltage to 800 Volts
- 300 A Surge Current Capability

**2N6504**  
**thru**  
**2N6509\***

\*Motorola preferred devices

**SCRs**  
**25 AMPERES RMS**  
**50 thru 800 VOLTS**

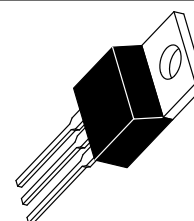

**CASE 221A-07**  
**(TO-220AB)**  
**STYLE 3**

### MAXIMUM RATINGS (T<sub>J</sub> = 25°C unless otherwise noted.)

Rating	Symbol	Value	Unit
* Peak Forward and Reverse Blocking Voltage <sup>(1)</sup> (Gate Open, T <sub>J</sub> = 25 to 125°C)	V <sub>DRM</sub> , V <sub>RRM</sub>	50 100 400 600 800	Volts
Forward Current (T <sub>C</sub> = 85°C) (180° Conduction Angle)	I <sub>T(RMS)</sub> I <sub>T(AV)</sub>	25 16	Amps
Peak Non-repetitive Surge Current — 8.3 ms (1/2 Cycle, Sine Wave) 1.5 ms	I <sub>TSM</sub>	300 350	Amps
Forward Peak Gate Power	P <sub>GM</sub>	20	Watts
Forward Average Gate Power	P <sub>G(AV)</sub>	0.5	Watt
Forward Peak Gate Current	I <sub>GM</sub>	2	Amps
Operating Junction Temperature Range	T <sub>J</sub>	-40 to +125	°C
Storage Temperature Range	T <sub>stg</sub>	-40 to +150	°C

### \*THERMAL CHARACTERISTICS

Characteristic	Symbol	Max	Unit
Thermal Resistance, Junction to Case	R <sub>θJC</sub>	1.5	°C/W

\*Indicates JEDEC Registered Data.

1. V<sub>DRM</sub> and V<sub>RRM</sub> for all types can be applied on a continuous basis. Ratings apply for zero or negative gate voltage; however, positive gate voltage shall not be applied concurrent with negative potential on the anode. Blocking voltages shall not be tested with a constant current source such that the voltage ratings of the devices are exceeded.

Preferred devices are Motorola recommended choices for future use and best overall value.

REV 2

## 2N6504 thru 2N6509

### ELECTRICAL CHARACTERISTICS ( $T_C = 25^\circ\text{C}$ unless otherwise noted.)

Characteristic	Symbol	Min	Typ	Max	Unit
* Peak Forward or Reverse Blocking Current ( $V_{AK} = \text{Rated } V_{DRM} \text{ or } V_{RRM}, \text{ Gate Open}$ ) $T_J = 25^\circ\text{C}$ $T_J = 125^\circ\text{C}$	$I_{DRM}, I_{RRM}$	— —	— —	10 2	$\mu\text{A}$ mA
* Forward "On" Voltage <sup>(1)</sup> ( $I_{TM} = 50 \text{ A}$ )	$V_{TM}$	—	—	1.8	Volts
* Gate Trigger Current (Continuous dc) (Anode Voltage = 12 Vdc, $R_L = 100 \text{ Ohms}$ ) $T_C = 25^\circ\text{C}$ $T_C = -40^\circ\text{C}$	$I_{GT}$	— —	— 25	40 75	mA
* Gate Trigger Voltage (Continuous dc) (Anode Voltage = 12 Vdc, $R_L = 100 \text{ Ohms}, T_C = -40^\circ\text{C}$ )	$V_{GT}$	—	1	1.5	Volts
Gate Non-Trigger Voltage (Anode Voltage = Rated $V_{DRM}, R_L = 100 \text{ Ohms}, T_J = 125^\circ\text{C}$ )	$V_{GD}$	0.2	—	—	Volts
* Holding Current (Anode Voltage = 12 Vdc, $T_C = -40^\circ\text{C}$ )	$I_H$	—	35	40	mA
* Turn-On Time ( $I_{TM} = 25 \text{ A}, I_{GT} = 50 \text{ mAdc}$ )	$t_{gt}$	—	1.5	2	$\mu\text{s}$
Turn-Off Time ( $V_{DRM} = \text{rated voltage}$ ) ( $I_{TM} = 25 \text{ A}, I_R = 25 \text{ A}$ ) ( $I_{TM} = 25 \text{ A}, I_R = 25 \text{ A}, T_J = 125^\circ\text{C}$ )	$t_q$	— —	15 35	— —	$\mu\text{s}$
Critical Rate of Rise of Off-State Voltage (Gate Open, Rated $V_{DRM}, \text{ Exponential Waveform}$ )	$dv/dt$	—	50	—	$\text{V}/\mu\text{s}$

\*Indicates JEDEC Registered Data.

1. Pulse Test: Pulse Width  $\leq 300 \mu\text{s}$ , Duty Cycle  $\leq 2\%$ .

FIGURE 1 — AVERAGE CURRENT DERATING

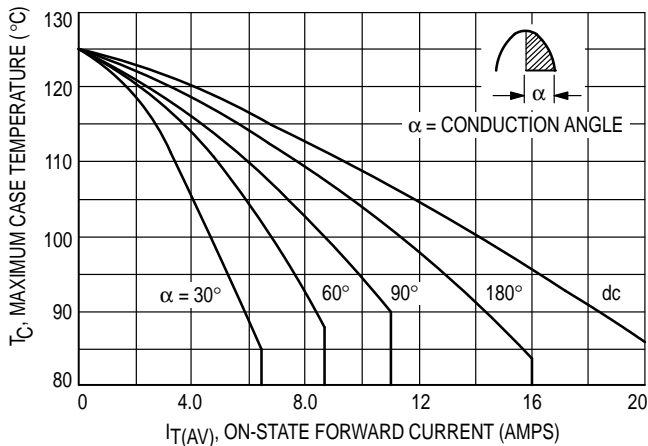

FIGURE 2 — MAXIMUM ON-STATE POWER DISSIPATION

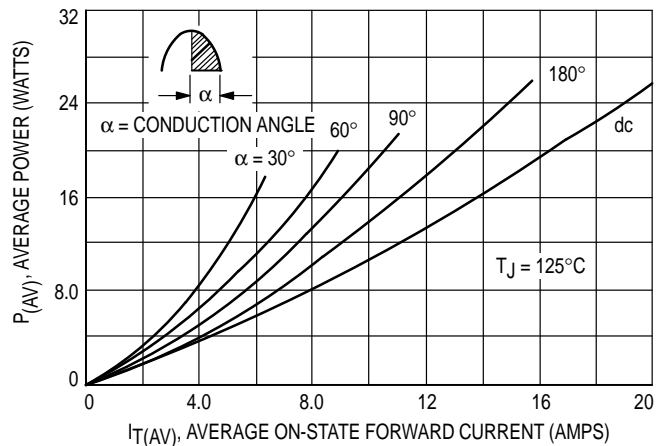

FIGURE 3 — MAXIMUM FORWARD VOLTAGE

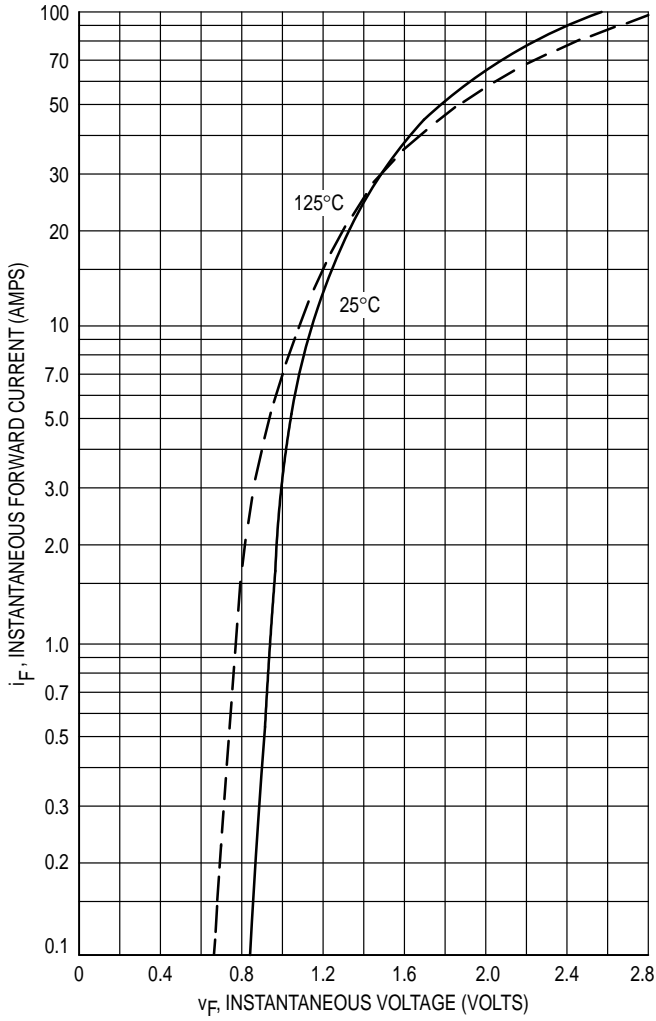

FIGURE 4 — MAXIMUM NON-REPETITIVE SURGE CURRENT

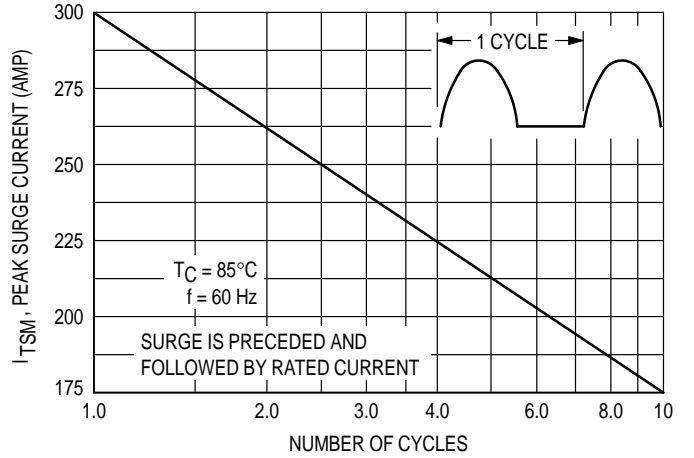

FIGURE 5 — CHARACTERISTICS AND SYMBOLS

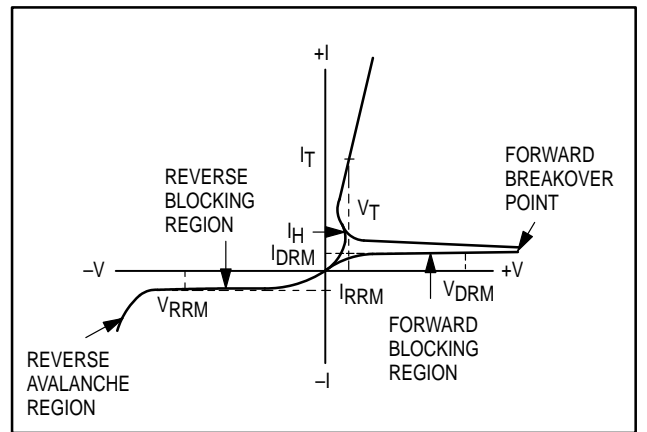
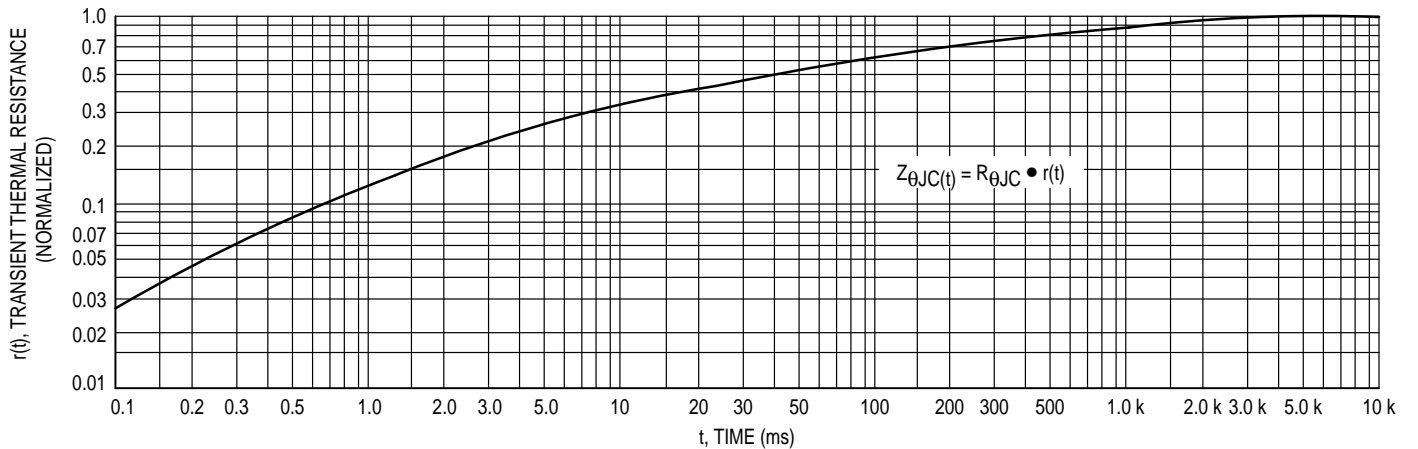

FIGURE 6 — THERMAL RESPONSE



TYPICAL TRIGGER CHARACTERISTICS

FIGURE 7 — GATE TRIGGER CURRENT

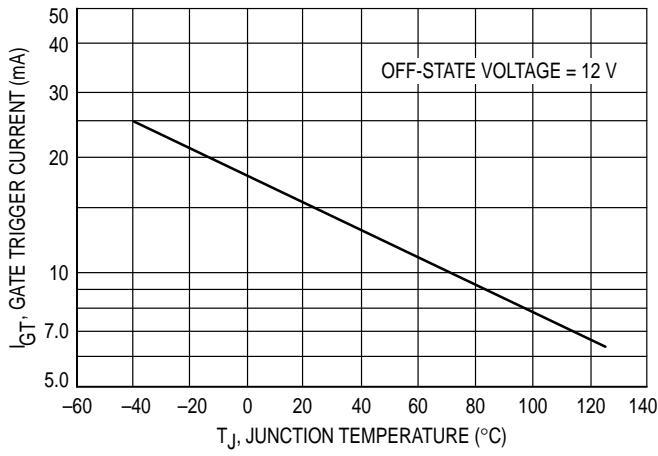

FIGURE 8 — GATE TRIGGER VOLTAGE

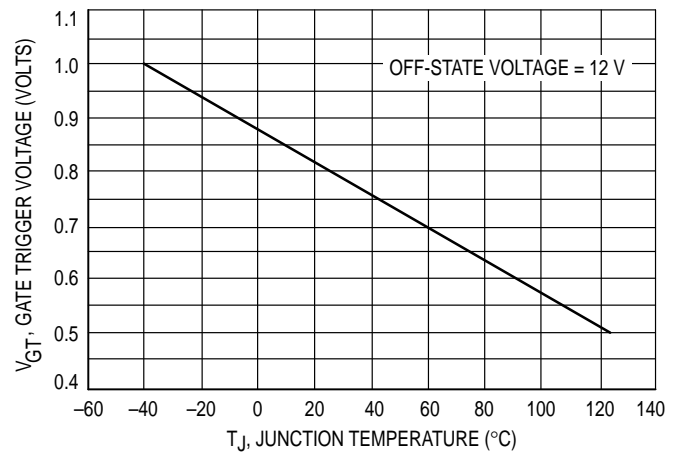
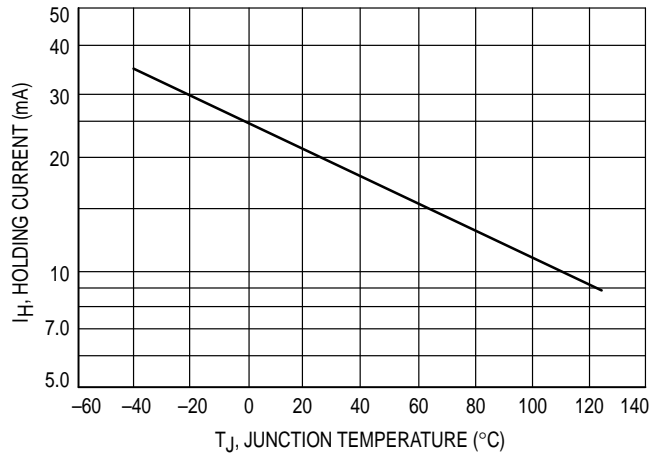
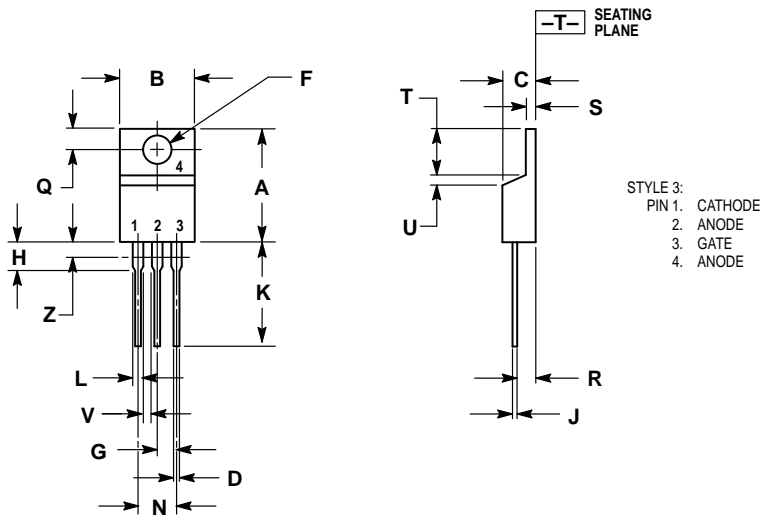

FIGURE 9 — HOLDING CURRENT



PACKAGE DIMENSIONS



- NOTES:  
 1. DIMENSIONING AND TOLERANCING PER ANSI Y14.5M, 1982.  
 2. CONTROLLING DIMENSION: INCH.  
 3. DIMENSION Z DEFINES A ZONE WHERE ALL BODY AND LEAD IRREGULARITIES ARE ALLOWED.

DIM	INCHES		MILLIMETERS	
	MIN	MAX	MIN	MAX
A	0.570	0.620	14.48	15.75
B	0.380	0.405	9.66	10.28
C	0.160	0.190	4.07	4.82
D	0.025	0.035	0.64	0.88
F	0.142	0.147	3.61	3.73
G	0.095	0.105	2.42	2.66
H	0.110	0.155	2.80	3.93
J	0.014	0.022	0.36	0.55
K	0.500	0.562	12.70	14.27
L	0.045	0.060	1.15	1.52
N	0.190	0.210	4.83	5.33
Q	0.100	0.120	2.54	3.04
R	0.080	0.110	2.04	2.79
S	0.045	0.055	1.15	1.39
T	0.235	0.255	5.97	6.47
U	0.000	0.050	0.00	1.27
V	0.045	—	1.15	—
Z	—	0.080	—	2.04

CASE 221A-07  
 (TO-220AB)  
 ISSUE Z

Motorola reserves the right to make changes without further notice to any products herein. Motorola makes no warranty, representation or guarantee regarding the suitability of its products for any particular purpose, nor does Motorola assume any liability arising out of the application or use of any product or circuit, and specifically disclaims any and all liability, including without limitation consequential or incidental damages. "Typical" parameters which may be provided in Motorola data sheets and/or specifications can and do vary in different applications and actual performance may vary over time. All operating parameters, including "Typicals" must be validated for each customer application by customer's technical experts. Motorola does not convey any license under its patent rights nor the rights of others. Motorola products are not designed, intended, or authorized for use as components in systems intended for surgical implant into the body, or other applications intended to support or sustain life, or for any other application in which the failure of the Motorola product could create a situation where personal injury or death may occur. Should Buyer purchase or use Motorola products for any such unintended or unauthorized application, Buyer shall indemnify and hold Motorola and its officers, employees, subsidiaries, affiliates, and distributors harmless against all claims, costs, damages, and expenses, and reasonable attorney fees arising out of, directly or indirectly, any claim of personal injury or death associated with such unintended or unauthorized use, even if such claim alleges that Motorola was negligent regarding the design or manufacture of the part. Motorola and  registered trademarks of Motorola, Inc. Motorola, Inc. is an Equal Opportunity/Affirmative Action Employer.

Mfax is a trademark of Motorola, Inc.

**How to reach us:**

**USA/EUROPE/Locations Not Listed:** Motorola Literature Distribution;  
P.O. Box 5405, Denver, Colorado 80217. 1-303-675-2140 or 1-800-441-2447

**JAPAN:** Nippon Motorola Ltd.; SPD, Strategic Planning Office, 141,  
4-32-1 Nishi-Gotanda, Shinagawa-ku, Tokyo, Japan. 81-3-5487-8488

**Customer Focus Center: 1-800-521-6274**

**Mfax™:** RMFAX0@email.sps.mot.com – TOUCHTONE 1-602-244-6609  
Motorola Fax Back System – US & Canada ONLY 1-800-774-1848  
– http://sps.motorola.com/mfax/

**ASIA/PACIFIC:** Motorola Semiconductors H.K. Ltd.; 8B Tai Ping Industrial Park,  
51 Ting Kok Road, Tai Po, N.T., Hong Kong. 852-26629298

**HOME PAGE:** <http://motorola.com/sps/>

